

Prospectives of monitoring biological activity in a red-legged partridge incubator with a carbon dioxide probe

Javier Garcia-Hierro^{1*}, Pilar Barreiro², Adolfo Moya-Gonzalez², José Ignacio Robla¹

(1 Centro Nacional de Investigaciones Metalúrgicas, Consejo Superior de Investigaciones Científicas, Av. Gregorio del Amo, 8, 28040 Madrid, Spain;

2 Dpto. de Ingeniería Agroforestal. ETSI Agrónomos. Universidad Politécnica de Madrid, Av. Complutense 3, Madrid, Spain)

Abstract: This study focuses on the relationship between CO₂ production and the ultimate hatchability of the incubation. A total amount of 43316 eggs of red-legged partridge (*Alectoris rufa*) were supervised during five actual incubations: three in 2012 and two in 2013. The CO₂ concentration inside the incubator was monitored over a 20-day period, showing sigmoidal growth from ambient level (428 ppm) up to 1700 ppm in the incubation with the highest hatchability. Two sigmoid growth models (logistic and Gompertz) were used to describe the CO₂ production by the eggs, with the result that the logistic model was a slightly better fit ($r^2=0.976$ compared to $r^2=0.9746$ for Gompertz). A coefficient of determination of 0.997 between the final CO₂ estimation (ppm) using the logistic model and hatchability (%) was found.

Keywords: carbon dioxide, embryonic development, red-legged partridge, hatchability, growth analysis

Citation: Garcia-Hierro, J., P. Barreiro, A. Moya-Gonzalez, and J.I. Robla. 2016. Prospectives of monitoring biological activity in a red-legged partridge incubator with a carbon dioxide probe. *Agric Eng Int: CIGR Journal*, 18(1):353-362.

1 Introduction

There are no published studies on CO₂ levels during incubation for partridge eggs as most of the published studies on this issue refer to broiler eggs. These studies reveal several factors that influence embryonic development (ED) and the duration of the incubation process, including the genetic line and age of the breeders, and the environmental conditions in which the eggs are stored and incubated: temperature (T), relative humidity (RH), gas levels and altitude (Onagbesan et al., 2007). All these parameters must be controlled in order to achieve optimal hatchability (H) and good chick quality.

An extensive review by Onagbesan et al. (2007) was published on the effect of environmental O₂ and CO₂ concentrations on H, chick quality and post-hatch growth. The effect of hyperoxia, hypoxia and hypercapnia on such quality parameters was described, and CO₂ concentration

was identified as a key parameter. Early studies (Taylor et al., 1956; Taylor and Kreutziger, 1965, 1966, 1969; Taylor et al., 1971) demonstrated that very high concentrations of CO₂ (over 1%) during incubation caused a drop in H. A recent study of Han et al. (2011) confirms that a high level of CO₂ during the first four days of incubation inhibits the chick's ED and increases embryonic mortality. However, a high hypercapnia (4% CO₂) during the second half of incubation has no influence in embryonic growth or chick H (Everaert et al., 2007) but it increases the ascites death rate and decreases the body weight of broilers from week four onwards (Everaert et al., 2012).

Increasing CO₂ concentration up to 0.7% inside the incubator by non-ventilation during the first 10 days of incubation revealed faster ED and enhanced H; more obvious in the ascites-sensitive broiler line (De Smit et al., 2008). Buys et al. (1998) reported similar results, when CO₂ concentration reached 0.4% during the third week of incubation: reducing the incidence of ascites and increasing the hatching weight of the chicks.

Received date: 2015-09-29

Accepted date: 2015-11-13

*Corresponding author: Javier Garcia-Hierro Navas, Centro Nacional de Investigaciones Metalúrgicas, Av. Gregorio del Amo, 8, 28040 Madrid, Spain. E-mail: j.hierro@cenim.csic.es.

The aforementioned studies focus on the influence of different levels of CO₂ during the various stages of incubation on ED, H and other physiological parameters.

CO₂ is released by the eggs from the natural reservoir in the albumen combined with the metabolic production of the embryo during incubation. This CO₂ production rate is directly related with O₂ consumption, as it is set out in the metabolic reactions of cellular respiration. Assuming a respiratory quotient of 0.72 (Decuyper, 1984), every litre of O₂ consumed by the embryo is equivalent to the production of 4.69 kcal of heat (Vleck and Vleck, 1980). Heat production under normal incubation temperature, computed on the basis of O₂ consumption, egg mass and caloric heat equivalent, follows an exponential function (Tzschentke, 2008). Early studies on O₂ consumption rate during incubation reflect a common pattern between precocial species as is our case, following an exponential increase until a plateau at around 85% of total incubation time (Prinzinger and Dietz, 1995). The evolution in ambient CO₂ concentration during incubation could then be used to determine the biological activity of the embryos and thus to estimate the ultimate H. The purpose of this

study is to monitor and to establish the connection between the CO₂ concentration during an actual incubation of red-legged partridges (*Alectoris rufa*) and the ultimate H.

2 Materials and methods

2.1 Incubations

A commercial poultry incubator (VICTORIA srl, Guanzate, Italy) was used; offering precise control over T and RH, as stated in previous research. During the 20-21 day incubation period, the eggs were smoothly rotated from 45° to 135° and vice versa. A total amount of 42516 red-legged partridge eggs were supervised during five different incubations: three in 2012 and two in 2013 (Table 1). Inside the incubator, T and RH were set at 37.5 °C and 40% respectively. A single probe was used for T control, as well as an ordinary ON-OFF system that activated two 850 W heating resistors when T fell below 37 °C, and switched them off whenever the T reached 37.7 °C. The RH controller used a wetting roller located on the incubator floor which was activated when RH fell below 37% and deactivated when RH rose above 42%.

Table 1 Summary of incubations

	Incubation -Dates	Monitoring days, records	Eggs	Hatched	Hatchability, % Malformations, %	Average T inside incubator, °C	Average T in incubation room, °C
1	13 March - 4 April 2012	9 to 20 (5280)	7840	5133	65.5 -	36.9 (0.4)	18.7 (2.6)
2	6 -27 April 2012	8.7 to 20.7 (5760)	9072	6951	76.6 -	36.9 (0.6)	15.8 (2.4)
3	30 April - 19 May 2012	1.5 to 20.5 (9120)	9072	6523	71.9 -	37.1 (0.5)	22.0 (2.1)
4	19 March - 9 April 2013	0 to 20.6 (9864)	8262	3022	40.7 4.1	37.3 (0.6)	13.5 (1.8)
5	16 April -7 May 2013	0 to 20.7 (9938)	9070	2769	34.9 4.4	37.1 (0.6)	17.8(3.2)

The average CO₂ concentration with the incubator empty was around 400 ppm. The exchange of gases, by means of natural ventilation, between the incubator and the incubation room took place through two circular windows (with an area of 225 cm²), located in the top of incubator with adjustable openings (50% as adjusted by producers). On average, 7992 ambient measurements were recorded per incubation (Table 1).

2.2 Monitoring system

T and RH were monitored using sensors (model SHT75, Sensirion AG, Staefa, Switzerland) located inside and outside the incubator. An Infrared (IR) sensor (model EE82-5C2, E+E ELEKTRONIK GES.M.B.H., Engerwitzdorf, Austria) was used to supervise the CO₂ concentration inside the incubator. This model was calibrated in the range of 0-5000 ppm with an accuracy of 50 ppm. It provided a linear analogue output between

0-5 V that was measured by an ADVANTECH module ADAM 4019+ (Advantech Co., Beijing, China). A RS485 – USB converter module (ADVANTECH model ADAM™ 4521) transferred the data to a standard

computer. Software based on TESTPOINT (Capital Equipment Corporation, 2001) was used to read, transform and record data in real time. The Figure 1 shows the diagram of data acquisition system.

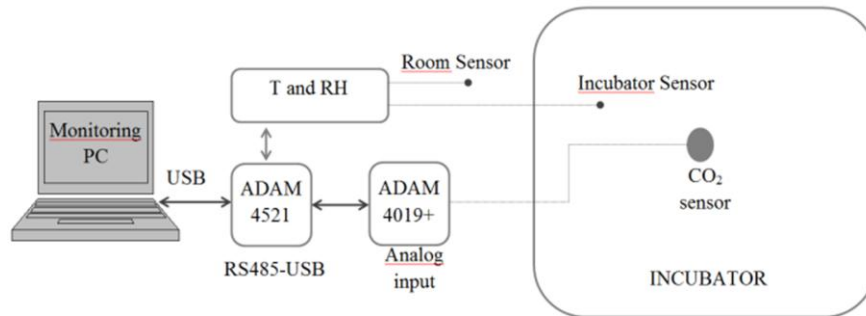

Figure 1 Diagram of data acquisition system

2.3 Data analysis

Logistic and Gompertz models are used to describe the increase in the CO₂ concentration inside the poultry incubator, which is expected to be proportional to the growth of the embryo inside the eggs. These sigmoid equations are commonly employed in growth analysis (Zwietering et al., 1990; Ricklefs, 2010). Table 2 expresses the models and their corresponding parameters.

Calibration of both models was performed using non-linear least squares regression with Matlab 7.6.0 (R2008a) (The MathWorks Inc., Natick (MA, USA), which makes use of the Levenberg-Marquardt algorithm (LMA) (Levenberg, 1944; Marquardt, 1963).

The LMA interpolates between the Gauss–Newton algorithm (GNA) and the method of gradient descent. As it is more robust than the GNA, in many cases it finds a solution even if it starts very far off the minimum.

Table 2 Logistic and Gompertz model parameterisation

	Logistic model	Gompertz model
Equation	$y = d + \frac{a}{1 + \exp^{b-cx}}$	$y = d + a \cdot \exp^{-\exp^{(b-cx)}}$
Time at point of inflection		$t_{ip} = \frac{b}{c}$
Maximum CO ₂ rate	$\mu_m = \left(\frac{dy}{dt}\right)_{t_{ip}} = \frac{a \cdot c}{4}$	$\mu_m = \left(\frac{dy}{dt}\right)_{t_{ip}} = \frac{a \cdot c}{\exp(1)}$
Initial Concentration	$y = d + \frac{a}{1 + \exp^b}$	$y = d + a \cdot \frac{1}{\exp^{\exp^b}}$

Limit

$$y(t \rightarrow \infty) = d + a$$

Note: “d” and “a” are equal to the initial and final CO₂ concentrations respectively. The point of inflection of the curves was determined as the value for which the second derivative is zero, and the maximum CO₂ production rate corresponds to the value of the first derivative of the function for t=t_{ip}.

In the programme, the starting points are set based on the experimental data to reduce the number of iterations and thus the calculation time, and the algorithm computes the parameters and their 95% confidence intervals with the lowest residual sum of squares. The programme can restrict the final adjustment by setting upper and lower limits to obtain consistent values for the parameters.

3 Results and discussion

According to the average incubator T values (Table 1), no relevant differences were found between the various incubations. The average T of all the incubations is in the same range, considering its standard deviation. These results are consistent with a previous study. A correlation analysis of the indoor and outdoor T of the incubator shows a poor relationship (correlation coefficient= -0.322). Table 1 also shows the percentages of H, with a maximum value of 76.6%, which is low compared to other studies where up to 95% was achieved (Everaert et al., 2007; De Smit et al., 2008). This fact is congruent with a lack of prior knowledge about the fertilised eggs in our study. The H of the three

incubations in 2012 was similar and reached an acceptable level comparable to historical records at the farm. However, the H of the two incubations in 2013 was dramatically lower. According to the explanation provided by the owners of the game farm, this drop in H was due to the co-occurrence of various factors: an excessive egg storage period, an egg storage T that was higher than normal, and a high number of new breeders. In this sense, the manuscript of Gomez-de-Travededo et al. (2014) indicates that the rate of late embryo mortality increases with the storage period from 3% for 7 days storage up to 13% for 42 days. In addition, high temperature storage (15 °C) reduces the hatchability up to a 4%.

3.1 Stability of CO₂ probe

The stability of the CO₂ sensor was analysed on the basis of 864 measurements (1.8 days) taken inside the empty incubator while the T controller was on. The coefficient of variation in CO₂ was 2.5% with an average

of 428 ppm, which was taken as the control value. No such data were provided in other recent related publications (Han et al., 2011).

3.2 Evolution of CO₂ during incubations

Figure 2 represents the CO₂ concentration for the five incubations, together with Gompertz and logistic estimations. The initial concentration is always around 400 ppm, reaching a maximum of 1770 ppm for the second incubation in 2012 (highest hatching rate 76.6%). Buys et al. (1998) reported CO₂ concentrations of up to 4000 ppm in non-ventilated incubations, while De Smit et al. (2008) managed to achieve 7000 ppm. However, the study by De Smit et al. (2006) showed a CO₂ concentration of around 1000 ppm in a ventilated incubator with 800 Cobb eggs. So, it has to be taken into account that in our study slight natural ventilation was allowed. The species used was also different (red-legged partridge instead of hens). These variations may explain the differences in CO₂ levels.

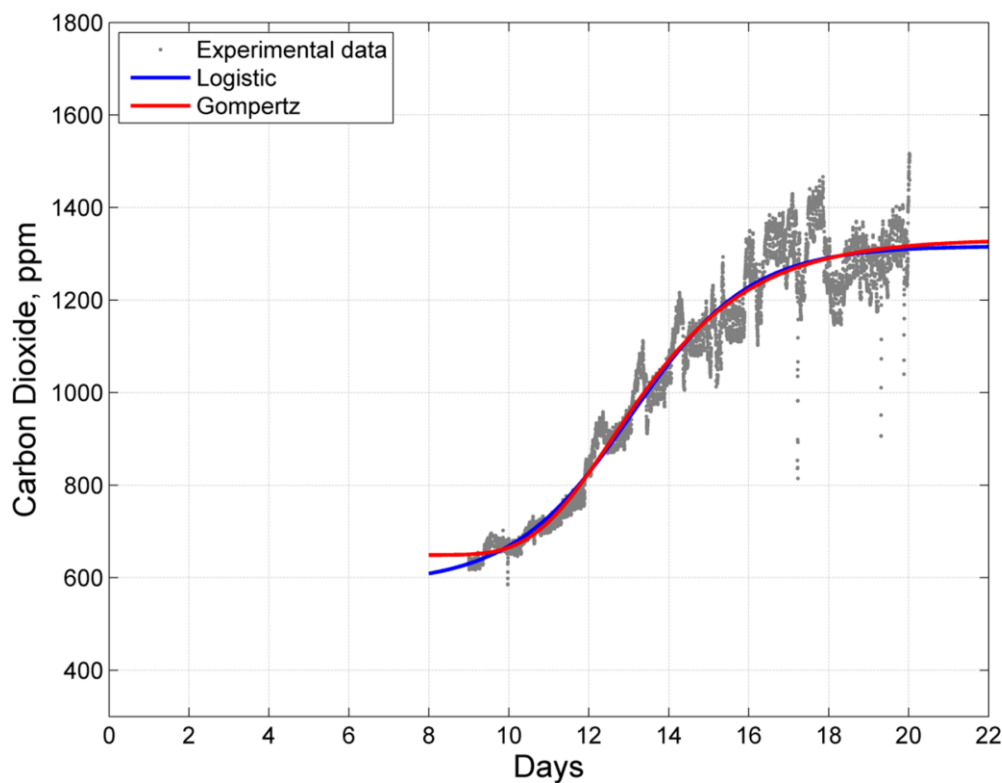

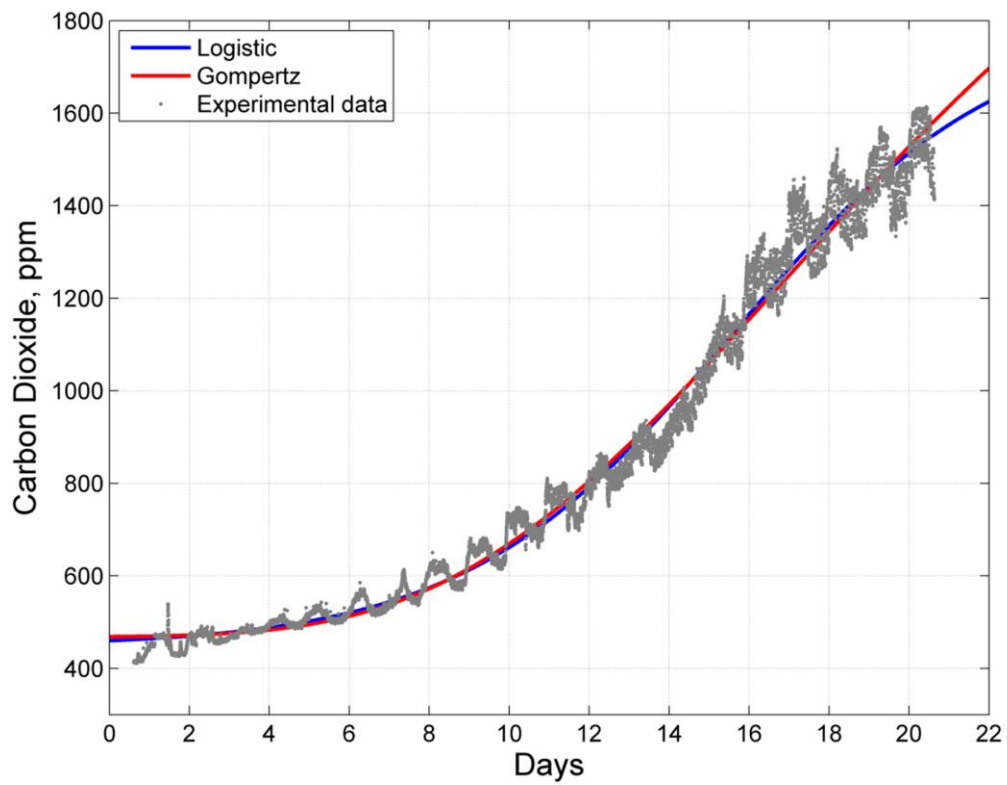
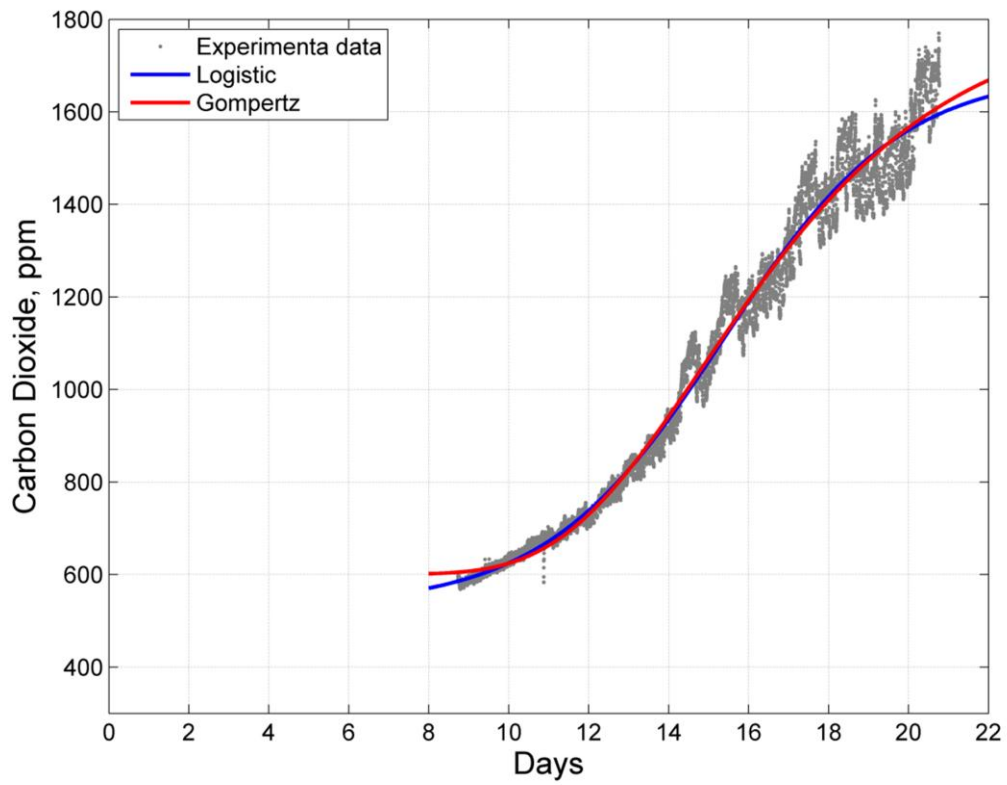

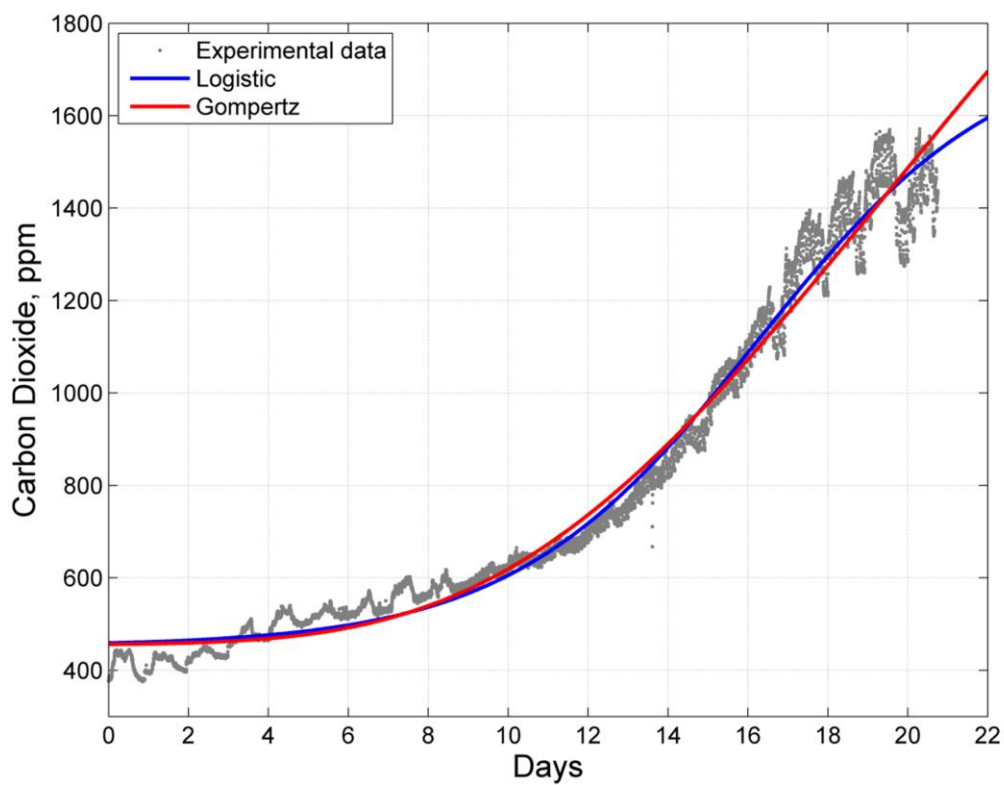
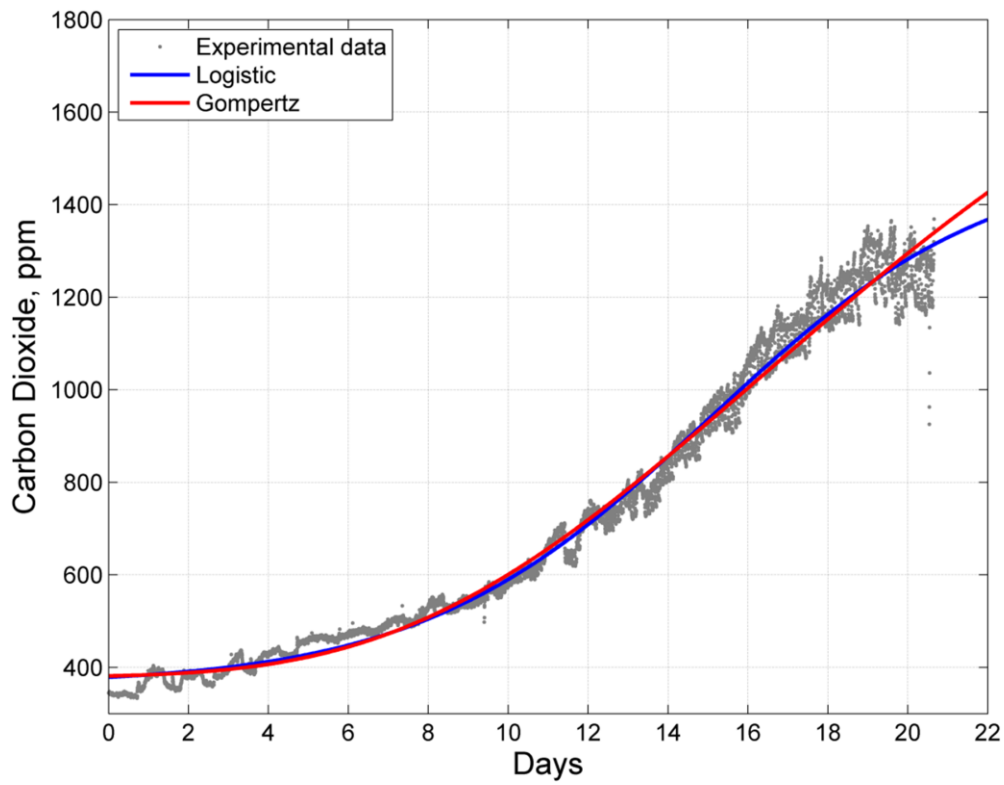

Note: The logistic model (blue line) and the Gompertz model (red line) curves fit the experimental data (grey dots).

Figure 2 CO₂ concentration during the five incubation processes (1 to 5 from top to bottom)

In all cases, during the first 8 days of incubation, the CO₂ level increased slowly. CO₂ production accelerated and reached the maximum rate at about the 14th-15th day. CO₂ production then decelerated and grew asymptotically towards the limit concentration.

Concerning CO₂ fluctuations during incubation, these were negligible (below 50 ppm range) during the first two days, while clearly visible from the 6.5th day onwards. This fact was confirmed for all incubations.

(1) To sum up, three types of variations in CO₂ concentration were found:

(2) An increase in CO₂ concentration (around 1200 ppm range) throughout the incubation process because of the metabolic activity of the embryo within the egg.

(3) Daily variations that concur with the day-night cycles, amplified at the end of the incubation (maximum 200 ppm range).

(4) Variations associated to slight T oscillations due to controller (up to 120 ppm range).

The CO₂ levels considered in the literature reviewed are far superior to those achieved in the five incubations supervised. The CO₂ levels reached at the end of the incubations are low (<0.2%) to cause physiological effects or have any direct effect on H. As it has been describe by Everaert et al. (2007), a high concentration of CO₂ (4%) during the second half of incubation has no influence on hatchability and embryo.

3.3 Modelling metabolic activity

There are two proposed models that fit the CO₂ concentration response: the Gompertz and the logistic models (Table 3). Both may be adjusted by means of the non-linear procedures described above. The red line in Figure 2 refers to the Gompertz model, while the blue line presents the logistic fit and grey dots represent experimental data. No examples of such use were found in the literature even though experimental data with similar behaviour were found (De Smit et al., 2006).

Table 3 Fit parameters of logistic and Gompertz equations for the analysis of experimental CO₂ concentration

Incubation	1		2		3		4		5	
Lowest CO ₂ , ppm	585		568		411		333		376	
Highest CO ₂ , ppm	1516		1770		1614		1369		1572	
Parameter	Log	Gomp	Log	Gomp	Log	Gomp	Log	Gomp	Log	Gomp
a, ppm	732	683	1159	1219	1350	2082	1150	1750	1316	2683
b	8.772	6.417	6.920	4.201	4.658	2.088	4.176	1.887	5.289	2.102
c, /days	0.672	0.510	0.450	0.283	0.2992	0.124	0.278	0.116	0.326	0.107
d, ppm	585	649	530	601	447	468	361	379	452	456
y(t=0) (ppm)	585	649	531	601	460	469	378	381	459	457
y(t=20 days) (ppm)	1310	1317	1560	1567	1514	1527	1281	1294	1471	1480
t _{ip} , days	13.1	12.6	15.4	14.8	15.6	16.8	15.0	16.3	16.2	19.6
µm (ppm days-1)	123	128	130	127	101	95	80	75	107	106
r ²	0.9482	0.9480	0.9795	0.9796	0.9852	0.9831	0.9868	0.9840	0.9799	0.9755

According to the estimated CO₂ concentration from 20th day (Figure 2), the logistic model seems to be more realistic in showing the asymptotic increase in the CO₂ level.

The time (t_{ip}) corresponding to the maximum CO₂ increasing rate is dependent on the model used. In this case it was around 16.0 days (± 1.1) according to the Gompertz model and 15.1 days (± 0.5) using the logistic model. t_{ip} should be related to the peak in ED. Maximum CO₂ increasing rate is achieved at 70% of total

incubation time, and becomes stable by 85% of the total incubation time, when eggs are taken to the hatcher on the two phase incubation adopted at the farm. This timing fits with the expected evolution for precocial species (Prinzinger and Dietz, 1995) with a first stage of exponential growth as described by Tzschentke (2008).

3.4 Estimating metabolic activity and hatchability

The variation in CO₂ due to endogenous production is related to the biological activity of the embryos and thus to

their potential ultimate H. The correlation between these two variables was determined.

In this study no daily control of living embryos (by opening the eggs) was performed since there was no access available to the interior of the incubator (20-21 days). Only the ultimate H (3 days after incubator) was available. The estimated CO₂ concentration on 20th day according to the logistic and Gompertz models was highly correlated to H ($r^2=0.994$) (Figure 3), based on the 2012 incubations.

According to the logistic model, in 2013, the hatching rate should have been 72.9% and 79.6% in the two incubations, while experimental hatching was quantified at 40.7% (36.6% + 4.1%), and 34.9% (30.5% + 4.4%). Gomez-de-Travededo et al. (2014) report that the length of the storage period for red-legged partridge eggs significantly reduces the H of the fertile eggs, while increasing late embryonic mortality. This fact would explain the increase in CO₂ found in 2013, without the corresponding H.

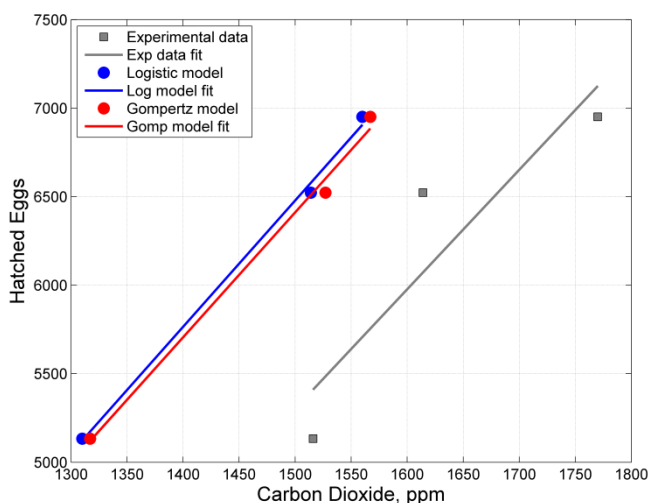

Note: Logistic fit (blue line) equation: y (hatched eggs) = $7.13 x$ (ppm) - 4221 with an r^2 of 0.997, Gompertz fit (red line) equation: $y = 7.06 x - 4173$ with an r^2 of 0.994, and experimental maximum CO₂ level (solid line): $y = 6.75x - 4826$ with an r^2 of 0.828.

Figure 3 Correlation between the estimated CO₂ level on 20th day and the eggs that ultimately hatched

3.5 Sensitivity analysis of the models

The analysis of correlations between the model parameters allows to assess for the possible existence of

redundancy. Table 4 includes the correlation coefficients between the parameter values adjusted for both types of models (Gompertz and logistic). The Gompertz shows a higher level of redundancy (correlation between two parameters) than the logistic model. The Gompertz and the logistic models show a degree of redundancy between parameters “b” and “c”. In fact a value that is taken as representative is “b/c” (point of inflection) which means that both are combined in a single reference value.

Table 4 Correlation of parameters for logistic and Gompertz models

	Logistic			Gompertz				
	a	b	c	d	a	B	c	d
a	1	-0.70	-0.78	-0.54	1	-0.80	-0.83	-0.63
b	-0.70	1	0.985	0.970	-0.80	1	0.996	0.934
c	-0.78	0.985	1	0.915	-0.83	0.996	1	0.897
d	-0.54	0.970	0.915	1	-0.63	0.935	0.897	1

4 Conclusions

The red-legged partridge incubations (five in total in 2 years) were successfully supervised using a standard commercial off-the-shelf CO₂ sensor.

Both the Logistic and the Gompertz models allow assessing the evolution in ambient levels and estimating the final CO₂ level after 20 days of incubation with coefficients of determination (r^2) of around 0.97.

The estimated CO₂ concentration on the 20th day was correlated with H and both the logistic and the Gompertz models achieved good results ($r^2=0.997$ and $r^2=0.994$, respectively).

Any exception occurring in the hatcher (last 3 days of incubation) will significantly affect H, without being reflected in the incubator monitoring. This could have been the case in 2013, when a high percentage of unhatched eggs and malformations were found: 62% and 4% respectively. In those cases, according to the logistic model, the H rate should have been 70%, while the experimental H was quantified as below 40%. This seems to be related to the high incidence of malformations and to poor storage of the eggs prior to incubation.

Acknowledgements

The funding for this work was provided by the Spanish Ministry of Science and Innovation (MICINN) in the case of the Smart-QC (GL2008-05267-C03-03) project and the Spanish Agency for International Development Cooperation (AECID) in the case of the A/030569/10 project.

We would like to thank Francisco Pérez and Ángel Pérez from Finca Cinegetica Dehesa Vieja (Galapagar) for providing facilities, help and explanations.

References

- Buyts, N., E. Dewil, E. Gonzales, and E. Decuyper. 1998. Different CO₂ levels during incubation interact with hatching time and ascites susceptibility in two broiler lines selected for different growth rate. *Avian Pathology*, 27(6): 605-612.
- De Smit, L., V. Bruggeman, M. Debonne, J. K. Tona, B. Kamers, N. Everaert, and E. Decuyper. 2008. The effect of nonventilation during early incubation on the embryonic development of chicks of two commercial broiler strains differing in ascites susceptibility. *Poultry Science*, 87(3): 551-560.
- De Smit, L., V. Bruggeman, J. K. Tona, M. Debonne, O. Onagbesan, L. Arckens, and E. Decuyper. 2006. Embryonic developmental plasticity of the chick: Increased CO₂ during early stages of incubation changes the developmental trajectories during prenatal and postnatal growth. *Comparative Biochemistry and Physiology a-Molecular & Integrative Physiology*, 145(2): 166-175.
- Decuyper, E. 1984. Incubation temperature in relation to postnatal performance in chickens. *Archiv fur experimentelle Veterinarmedizin*, 38(3): 439-449.
- Everaert, N., B. Kamers, A. Witters, L. De Smit, M. Debonne, E. Decuyper, and V. Bruggeman. 2007. Effect of Four Percent Carbon Dioxide During the Second Half of Incubation on Embryonic Development, Hatching Parameters, and Posthatch Growth. *Poultry Science*, 86(7): 1372-1379.
- Everaert, N., H. Willemsen, M. Debonne, A. Witters, B. Kamers, V. M. Darras, and V. Bruggeman. 2012. Interaction between ascites susceptibility and CO₂ during the second half of incubation of two broiler lines: the effect on post-hatch development and ascites mortality. *Br Poult Sci*, 53(2): 262-269.
- Garcia-Hierro, J., J. I. Robla, P. Barreiro, B. Diezma, and E. Correa-Hernando. 2012. Design of a solar incubator. Part 1: monitoring temperature and enthalpy gradients under commercial production. In *International Conference of Agricultural Engineering- CIGR-AgEng*, Valencia.
- Gomez-de-Travededo, P., F. P. Caravaca, and P. Gonzalez-Redondo. 2014. Effects of storage temperature and length of the storage period on hatchability and performance of red-legged partridge (*Alectoris rufa*) eggs. *Poultry Science*, 93(3): 747-754.
- Han, H. B., X. Li, K. Yu, and Z. X. Lian. 2011. Effects of Different CO₂ Levels on Chicken Embryonic Development During Early Stage of Incubation. *Journal of Animal and Veterinary Advances*, 10(20): 2624-2630.
- Levenberg, K. 1944. A method for the solution of certain non-linear problems in least squares. *Quarterly Journal of Applied Mathematics*, II(2): 164-168.
- Marquardt, D. W. 1963. An algorithm for least-squares estimation of nonlinear parameters. *Journal of the Society for Industrial and Applied Mathematics*, 11(2): 431-441.
- Onagbesan, O., V. Bruggeman, L. De Smit, M. Debonne, A. Witters, K. Tona, and E. Decuyper. 2007. Gas exchange during storage and incubation of Avian eggs: effects on embryogenesis, hatchability, chick quality and post-hatch growth. *Worlds Poultry Science Journal*, 63(4): 557-573.
- Prinzinger, R., and V. Dietz. 1995. Qualitative course of embryonic O₂ consumption in altricial and precocial birds. *Respiration Physiology*, 100(3): 289-294.
- Ricklefs, R. E. 2010. Embryo growth rates in birds and mammals. *Functional Ecology*, 24(3): 588-596.
- Taylor, L. W., and G. O. Kreuziger. 1965. The gaseous environment of chick embryo in relation to its development and hatchability. 2. Effect of carbon dioxide and oxygen levels during the period of the fifth through the eighth days of incubation. *Poultry Science*, 44(1): 98-106.
- Taylor, L. W., and G. O. Kreuziger. 1966. The gaseous environment of chick embryo in relation to its development and hatchability. 3. Effect of carbon dioxide and oxygen levels during the period of the ninth through twelfth days of incubation. *Poultry Science*, 45(5): 867-884.
- Taylor, L. W., and G. O. Kreuziger. 1969. The gaseous environment of the chick embryo in relation to its development and hatchability. 4. Effect of carbon dioxide and oxygen levels during the period of the thirteenth through the sixteenth days of incubation. *Poultry Science*, 48(3): 871-877.
- Taylor, L. W., G. O. Kreuziger, and G. Abercrom. 1971. The gaseous environment of chick embryo in relation to its development and hatchability. 5. Effect of carbon dioxide and oxygen levels during terminal days of incubation. *Poultry Science*, 50(1): 66-78.
- Taylor, L. W., R. A. Sjodin, and C. A. Gunns. 1956. The gaseous environment of the chick embryo in relation to its development and hatchability 1. Effect of carbon dioxide and oxygen levels during the first four days of incubation upon hatchability. *Poultry Science*, 35(6): 1206-1215.
- Tzschentke, B. 2008. Monitoring the development of thermoregulation in poultry embryos and its influence by

- incubation temperature. *Computers and Electronics in Agriculture*, 64(1): 61-71.
- Vleck, C. M., and D. Vleck. 1980. Patterns of Metabolism and Growth in Avian Embryos. *American Zoologist*, 20(2): 405-416.
- Zwietering, M. H., I. Jongenburger, F. M. Rombouts, and K. Vantriet. 1990. Modeling of the bacterial-growth curve. *Applied and Environmental Microbiology*, 56(6): 1875-1881.