

Investigating Grain Separation and Cleaning Efficiency Distribution of a Conventional Stationary Rasp-bar Sorghum Thresher

K. J. Simonyan¹ and Y. D. Yiljep²

¹Agricultural Engineering Department, Michael Okpara University of Agriculture,
P M B 7267. Umudike-Umuahia. Nigeria.
Email: simonyan.kayode@mouau.edu.ng

². Agricultural Engineering and Irrigation Programme,
National Agricultural Extension and Research Liaison Services,
Ahmadu Bello University,
P M B 1067, Samaru – Zaria. Nigeria.

ABSTRACT

A stationary grain thresher was developed and used to study grain separation and cleaning efficiency distribution of the cleaning unit, fractionated by sieve and horizontal air stream, along the sieve length. The influence of feed rate, m , air speed, V_A and sieve oscillation frequency, F_S on cleaning efficiency of sorghum was explored. Grain separation along the sieve can be divided into three sections: increasing, peak and decreasing sections. Results showed that cleaning efficiency decreased with increasing sieve oscillations frequency and feed rate respectively. Cleaning loss increased with increasing sieve oscillation frequency, feed rate and air speed.

Keywords: Sorghum, sorghum thresher, sorghum cleaning, grain separation, cleaning loss, cleaning efficiency, sieving, feed rate, Nigeria.

1. INTRODUCTION

Harvesting and post harvest handling methods introduce contaminants such as stones, sticks, chaff and dust (Ogunlowo and Adesuyi, 1999) into grains, which needs to be cleaned. Materials from the threshing unit are mixtures of long stalks, chaff, small fragments of spikes, stalks, leaves and grains. Materials separated through the concave and sieves are composed of grains, chaff and other small components of material other than grain (mog) (Miu, 2003). Odigboh (2004) gave post harvest losses estimate in Nigeria to be up to 25 %. Hopfen(1969) pointed out that threshed grain require considerable additional cleaning before it can be used as food, whole or ground and even as seed. The cleaning process, he postulated, presents more difficulties than the actual threshing process.

Pneumatic cleaning is the process of using air to lift light, chaffy and dusty materials out of the grain while heavier materials move downward. Air is generated by natural or mechanical fan. However, the limitation of natural wind method for cleaning is its unpredictable direction, speed and continuity, high labour requirement and rather imprecise degree of separation (Aguirre and Garray, 1999). Aerodynamic characteristic of particle mixtures are important for cleaning. Hollatz and Quick (2003) reported that a combination of aerodynamic- mechanical process is used for grain cleaning and that it would be a simple

mechanical sieving process without fan. They also postulated that the cleaning process would turn to an aspiration process when air speed is high thereby separating grains and chaff by differences in terminal velocity and drag coefficient.

Picket and West (1988) defined sieving as a process in which material mixture is moved over a perforated surface with openings of specified shape and size having one or more oscillating sieves and a fan delivering air through the sieves. Air is used to remove light materials from mixtures, assist to position particles over sieve opening and moves particles along sieve surface if they do not pass through openings. Hollatz and Quick (2003) reported that at low feed rates, aerodynamic separation of grain from straw and chaff took place over the sieve and at higher feed rate, material particles were no longer supported aerodynamically, which forms a mat on sieve, increasing grain losses. Rothaug *et al.*, (2003) also reported that feed rate is an important parameter in separation.

Miu (2003) modeled vibratory cleaning sieve stochastically and divided overall movement of grain within chaff layer as segregation movement to the top of the sieve (diffusion created by the sieve vibration), transport movement along the sieve and passing through sieve openings. Transport of particles along an oscillating sieve influences the efficiency of the process and also affects metering of particulate substances along an oscillating pan (Elfverson and Regner, 2000) and particles caught in the opening reduce the sieving efficiency (Picket and West, 1988). Harrison and Blecha (1983) itemized parameters influencing sieving as size of the particle and sieve apertures, relative particle to sieve velocity, mean particle velocity and orientation of oblong particles. They also published that particle velocity is a function of frequency and amplitude of oscillation, sieve slope, hanger angle, friction between particle and sieve. Zao *et al.*, (1999) reported that grain conveyance on the sieve is influenced by air velocity, which leads to initial segregation of grain from materials other than grain.

Initial distribution of grains in the cleaning unit depends on degree of pre-segregation achieved during threshing, on grain pan and by stepping to the cleaning sieve (Beck and Kutzbach, 1996). Spread pattern has been reported as a good tool for evaluating material distribution (Grift, 2000) as it determines the quality of the distribution pattern and the effective width (Joshi *et al.*, 2006). Adewumi (2006) suggested studying the distribution and spread pattern of grain relative to the distance from the plane at which materials are discharged as an approach to investigating the separation of grain from materials other than grain in a horizontal air stream. This study was undertaken to investigate grain separation and cleaning efficiency distribution in the cleaning unit of a conventional stationary rasp- bar grain thresher.

2. MATERIALS AND METHODS

2.1 The Test-Rig

The test rig shown in Figure 1 is composed of: frame, hopper, threshing unit, sieve, reciprocating mechanism, blower and collecting boxes. The collecting boxes was 100 cm long divided into eight (8) compartments of equal distances of 11 cm each as done by Kutzbach (2003) and Rothaug *et al.*, (2003). The grains in each box were collected manually separately for analysis. A 3.75 kW (5 hp) petrol engine was used to prime the threshing, sieves and blower units. The parameters of the sorghum thresher are listed in Table 1.

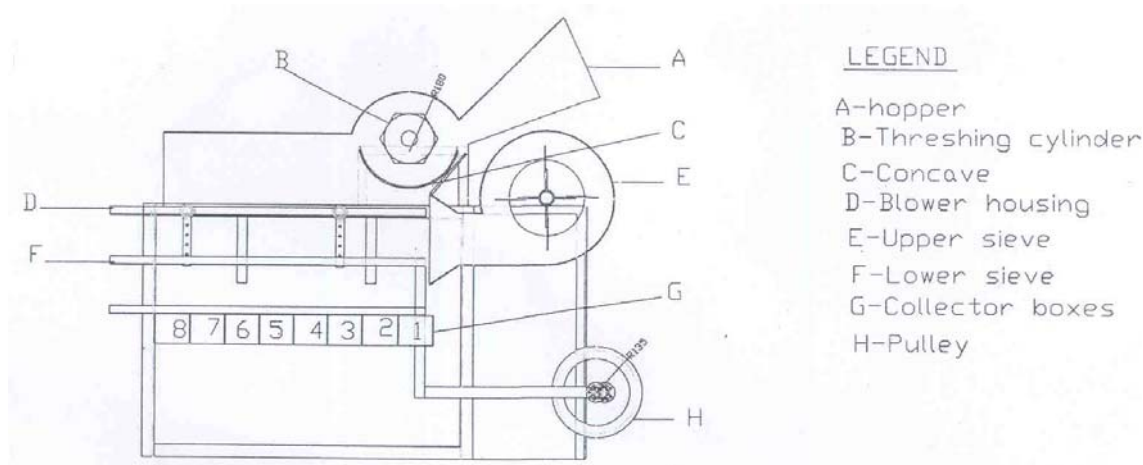

Figure 1. Sectional view of the sorghum thresher-testing rig.

Table 1. Parameters of the sorghum thresher test rig.

Parameter	Dimension, m
Overall length	1.474
Overall width	0.386
Overall height	1.323
Effective threshing cylinder diameter	0.140
Effective concave diameter	0.310
Sieve dimension	0.735 x 0.300
Sieve amplitude	0.05
Blower-major diameter	0.460
Blower- minor diameter	0.350
Blower- width	0.300
Blower-throat	0.150
Blower blades dimension	0.160 x 0.120
Sieve inclination	0 ⁰ (horizontal)
Air direction	0 ⁰ (horizontal)
Cylinder –concave clearance	0.015

2.2 Principle of Operation

Sorghum heads flowed under gravity to the threshing chamber where impact of revolving threshing cylinder threshed the grain. Grains were detached from sorghum head by a combination of stripping, rubbing and impact action. This action resulted in application of tensile, compressive, bending and twisting forces and their combination on a sorghum head. After contacting threshing cylinder, straw and loose kernels accelerate round the concave at different rates due to difference in coefficient of restitution of straw and grains. Figure 2 shows the threshing cylinder and concave. Grain that was freed falls through the concave on the reciprocating upper sieve. Threshed, unthreshed, partially threshed heads and some grains fell on the upper sieve. A conventional thresher does not have straw walker and grain pan.

Everything coming from threshing chamber is discharged on the upper sieve. Figure 3 gives an array of individual samples. As the sieves reciprocated there was horizontal and vertical displacement, which moves straw to the end of cleaning unit to be discharged. Air stream from the blower helped to disperse grain and straw, which allowed grain to pass through upper sieve hole to lower sieve. As grain and chaff passed across air stream, lighter materials are blown off, while clean grain was collected in collector boxes.

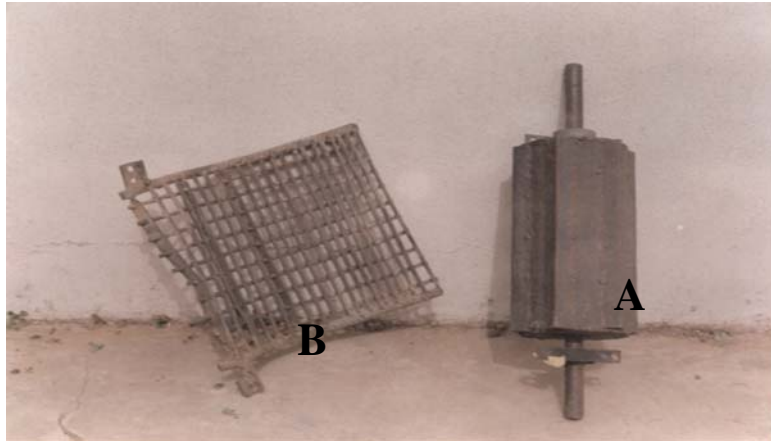
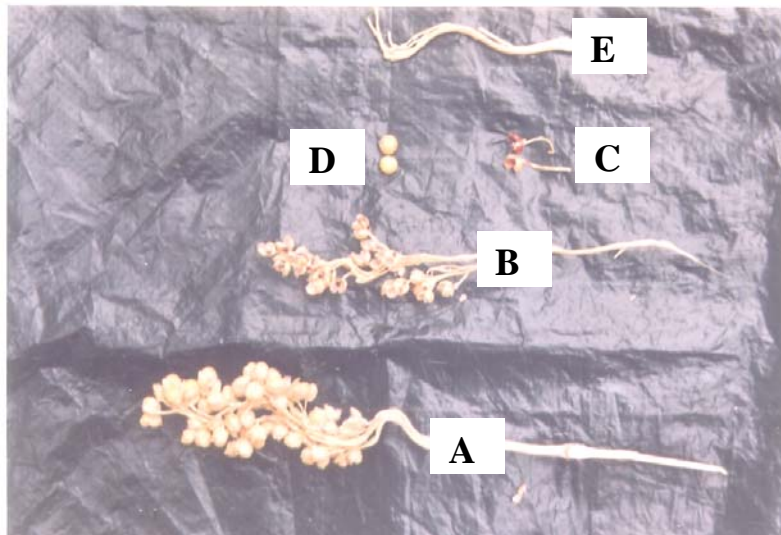

Figure 2. Threshing cylinder (A) and concave (B)



A =Unthreshed Sorghum ear; B = Threshed Sorghum ear; C = Chaff;
D = Sorghum grain; E =Stalk

Figure 3. Individual sorghum samples

2.3 Experimental Procedures

One kilogram of crop samples (Samsorg 17) was taken randomly from a heap of harvested sorghum heads and fed into the hopper manually. Feeding time, cylinder speed, blower speed and sieve reciprocation speed and frequency were recorded. Approximate feed rate was computed as weight of crop fed into the machine per unit time in kg/hr. Grain output was expressed in kg/hr by recording time taken in threshing operation and weight of grain recovered. Unthreshed tailings were separated from straw by manually threshing them and grains collected were weighed after cleaning manually to determine the threshing efficiency.

Feed rate of sieve was obtained by the output from the threshing cylinder with concave. Threshed product became input in the cleaning unit. Cleaned grains in each collector box were collected in a transparent polyethylene bag and labeled to be analyzed. Sample collected in each box was weighed with electronic weighing balance, and cleaned manually to quantify grain and material other than grain. Weight of cleaned grain was recorded for each box. The difference gave weight of impurities. This was used to determine cleaning efficiency. Materials captured coming off the back of the machine were processed to determine loss. Chaff collected was weighed using electronic weighing balance and cleaned manually to separate the grains. Cleaned grain separated from chaff was used to determine cleaning loss. Grain separation of materials recovered in the cleaning system were analyzed and evaluated by plotting frequency distribution curves. Three replications were made for each treatment level combination.

2.4 Parameters Measured

2.4.1 Moisture Content

Moisture content of samples was determined using the procedure detailed by Henderson *et al.*, (1997). The samples were dried at 130°C for 18 hours (ASAE, 2003). Weight loss of the samples was recorded and moisture in percentage determined. This was replicated three times. The moisture content was calculated as:

$$MC_{wb} = \frac{W_i - W_d}{W_i} \cdot 100 \quad 1$$

Where

MC_{wb} = moisture content, wet basis, %.

W_i = initial weight of sample, g.

W_d = dried weight of sample, g

2.4.2 Cleaning Efficiency (Purity):

$$\eta = \frac{G_o}{G_o + C_{cg}} \cdot 100 \quad 2$$

Where

η = cleaning efficiency, %

G_o = weight of pure grain at the outlet, g.

C_{cg} = weight of contaminant in cleaned grain, g.

2.4.3 Cleaning Loss:

$$C_L = \frac{G_i}{G_w} \times 100 \quad 3$$

Where

G_i = weight of grain at the chaff outlet, g.

G_w = weight of grain at input, g.

3. RESULTS AND DISCUSSION

3.1 Physical Characteristics of Sorghum

Table 2 presents the mean values and standard errors of axial dimensions of sorghum grain at different moisture contents. The table also contains the arithmetic mean, geometric mean and equivalent diameters of sorghum grain. Average values obtained for arithmetic mean, geometric mean and equivalent diameters were 4.20 mm, 4.16 mm and 4.18 mm respectively at moisture content of 16.5 %wb. At moisture content of 8.9 % wb, the values were 3.32 mm, 3.31 mm and 3.31 mm respectively. Average diameter of sorghum grains calculated by arithmetic mean, geometric mean and equivalent diameter methods in the moisture range of 8.9 – 16.5 % wb are similar. Arithmetic mean and geometric mean can therefore be used to determine average diameter of sorghum grain. This is useful in determining the diameter of sieve hole. Table 3 gives some physical properties of sorghum grain and straw materials.

Table 2. Means and standard errors of axial dimensions of sorghum grains

MC %wb	Major axis, L ₁ , mm	Medium axis, L ₂ , mm	Minor axis, L ₃ , mm	Arithmetic mean, L ₁ +L ₂ +L ₃ /3, mm	Geometric mean, (L ₁ L ₂ L ₃) ^{1/3} , mm	Equivalent diameter, D _e , mm
8.9	3.70(0.29)*	3.18(0.30)*	3.08(0.22)*	3.32	3.31	3.31
10.9	3.81(0.22)	3.29(0.18)	3.09(0.24)	3.40	3.38	3.41
12.3	4.04(0.04)	3.50(0.03)	3.61(0.05)	3.72	3.71	3.71
14.6	4.45(0.07)	4.39(0.12)	3.40(0.38)	4.08	4.05	4.06
16.5	4.62(0.06)	4.53(0.01)	3.44(0.07)	4.20	4.16	4.18

*Standard Error (SE)

Table 3. Some physical properties of sorghum grain and straw materials

Sample	Mass, g	Projected area, mm ²	Particle density, g/cm ³
Unthreshed	1.47 ± 0.35*	101.28 ± 40.68*	0.78 ± 0.14*
Threshed	0.37 ± 0.5	64.98 ± 16.66	0.31 ± 0.06
Grain	0.044 ± 0.007	4.66 ± 0.85	1.02 ± 0.20
Stalk	0.067 ± 0.02	26.14 ± 5.9	0.09 ± 0.02
Chaff	0.032 ± 0.008	7.34 ± 1.53	0.05 ± 0.01

* Standard Error (SE)

The average threshing efficiency of the sorghum-threshing rig used for the experiment was 99.85 %.

3.2 Grain Separation

The effect of feed rate on the distribution of grain separated along the sieve length is presented in Figure 4. Segregation and separation take place along the sieve length as grain and mog are being transported over the sieve. It has been reported that the thickness and looseness of grain – mog layer on the sieve influences separation (Rothaug *et al.*, (2003)). The separation at feed rate less than 611 kg/h can be divided into 3 sections: increasing, peak and decreasing sections. The increasing section occurred in sieve length 10-30 cm, the decreasing section occurred in sieve length of 50-80cm. However, at a high feed rate of 680kg/h, it takes a longer length for the grain to be separated from the mog. This may be due to the denseness of the mog, which made diffusion of grain through the mog to be longer. Similar result was obtained for wheat and chopped wheat straw by Rothaug *et al.*, (2003).

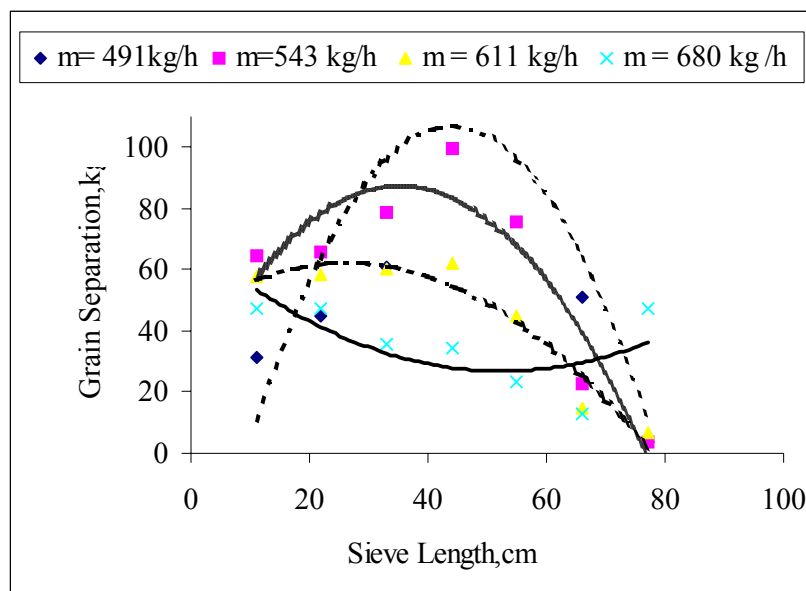

Figure 4. Grain separation distribution along sieve length.

3.2 Effect of Sieve Oscillation Frequency

The effect of sieve oscillating frequency on cleaning efficiency is given in Figure 5. There was generally a decrease in cleaning efficiency with increasing sieve oscillation frequency along the sieve length. The decrease in cleaning efficiency with increasing sieve oscillations may be due to less resident time of materials to be separated on the sieve. Harrison and Blecha (1983) described that the transport of particles along oscillating sieves, which is a function of sieve oscillation frequency, affects the efficiency of the process and affects metering of particulate substances along the sieve. Feller and Foux(1975) indicated that the frequency affects the passage of particles through the sieves.

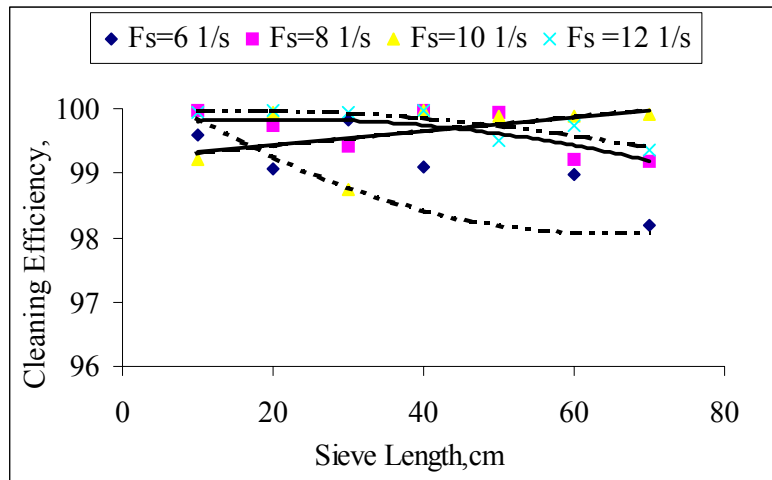

Figure 5. Effect of the sieve oscillating frequency on the cleaning efficiency

The effect of sieve oscillation frequency on the cleaning loss is presented in Figure 6. There was an increase in cleaning loss with increasing sieve oscillation frequency ranged between 6 oscillations per seconds and 12 oscillations per seconds. At 6 sieve oscillations per second, the cleaning loss is 9.73 % but at 12 sieve oscillations per second, the loss increased to 54 %. The relationship between the grain loss and the sieve oscillation frequency is given by the quadratic equation

$$C_L = 72.57 - 19.46 \alpha + 1.50 \alpha^2 \quad 4$$

The coefficient of determination R^2 is 0.99. Increasing sieve oscillation frequency allows less resident time for materials to be separated to stay on the sieve. Thereby it will not allow it to pass through the sieve holes. Also, as material is about passing through the hole, oscillating sieve may impinge force on the grain materials, thereby imparting it away as loss.

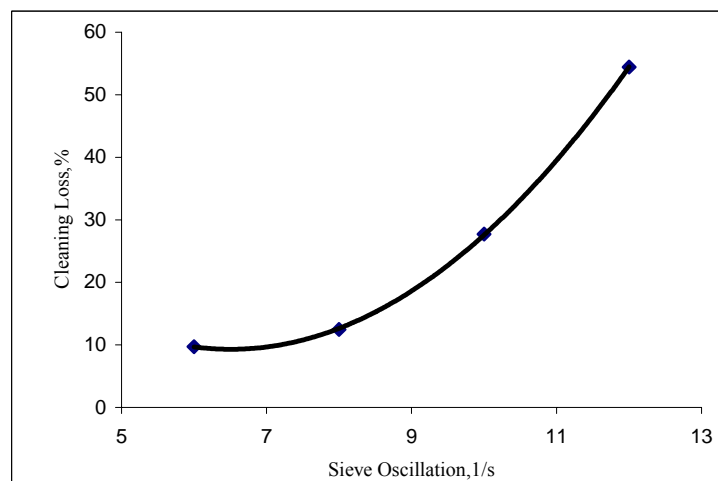

Figure 6. Effect of sieve oscillation frequency on cleaning loss

3.3 Effect of Feed Rate

Figure 7 gives the effect of feed rate on cleaning efficiency along the sieve length. There was a decrease in cleaning efficiency along the sieve length with increasing feed rate. The behaviours of cleaning efficiency against feed rate may be due to increasing load intensity on the sieve. Multiple particles act as obstructions to airflow. An increase in the number of particles causes turbulence while a decrease lowers the free stream turbulence intensity, which causes the drag coefficient to decrease (Mkomwa, 1988) for alfalfa. Rothaug *et al.*, (2003) also reported that overloaded sieves decrease seriously the performance of the cleaning unit and that low throughput caused high grain separation rates.

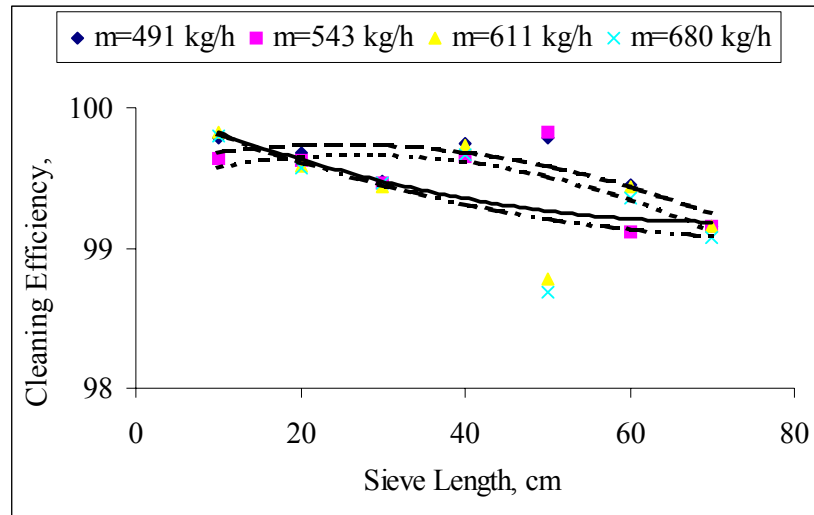

Figure 7. Effect of feed rate on the cleaning efficiency

The effect of feed rate of the materials to be cleaned on grain cleaning loss is given in Figure 8. There was an increase in cleaning loss with increasing feed rate within the range of 491 kg/h and 680 kg/h. When the feed rate was 491 kg/h, cleaning loss is 10 % and when feed rate was 680 kg/h, cleaning loss increased to 54%. The quadratic equation describing the relationship between the grain cleaning loss and feed rate of material is given by

$$C_L = 441.69 - 1.6743 F_r + 0.0016 F_r^2 \quad 5$$

The coefficient of determination is 0.99. The increase in cleaning loss with feed rate may be due to load intensity on the sieve, which results in matting on the sieve with material other than grain blocking sieve holes, thereby increasing cleaning loss. Lee and Winfield (1969) reported that at high feed rate, material particles are no longer supported aerodynamically, which forms a mat on sieve, increasing grain losses. Wacker(2003) showed an increase in grain loss with increasing throughput of mog.

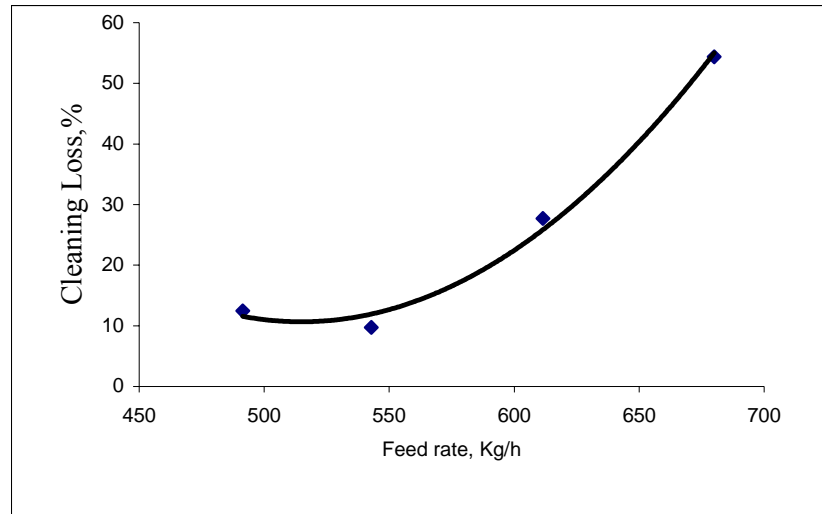

Figure 8. Effect of feed rate on cleaning loss

3.5 Effect of Air Speed

There was a decreasing cleaning efficiency with increasing sieve length for the various air speeds. The cleaning efficiency was higher at initial sieve length, which decreased progressively along the sieve length.

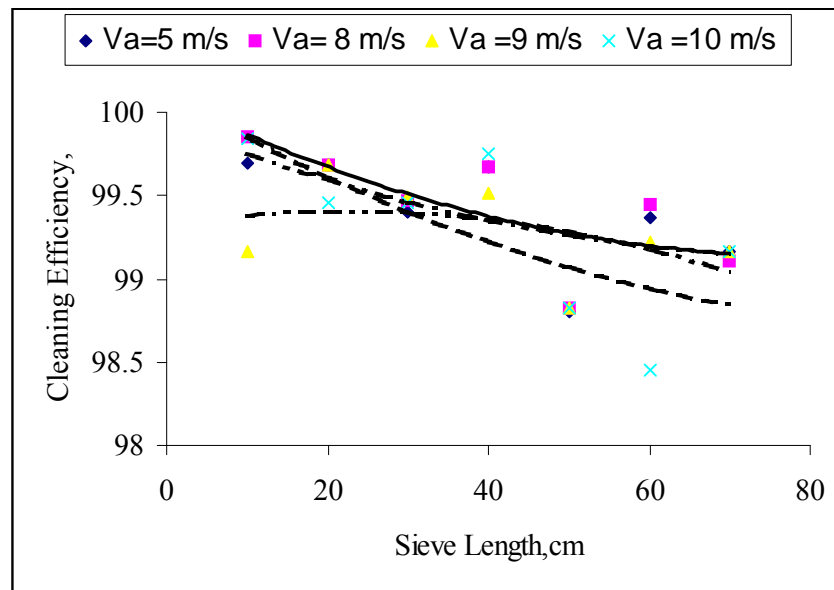

Figure 9. Effect of air speed on cleaning efficiency

Figure 10 presents the effect of air speed on cleaning loss. The graph shows an initial decrease in cleaning loss with increasing air speed. Then, the air is insufficient to separate impurity, but an increase in air speed cause cleaning loss to increase. Hollatz and Quick

(2003) reported that excessive air velocity fluidizes the grain, carrying it to the back of the sieve and depositing it along with the chaff. The quadratic equation depicting the relationship between cleaning loss and air speed within the range 5.00 m/s and 10 m/s is given by

$$C_L = 589.23 - 35.71V_a + 2.9343V_a^2 \quad 6$$

The coefficient of determination R^2 is 0.97. The behaviour of the relationship may be due to initial insufficient air for cleaning and as the air increased the grain cleaning loss blown away thus increased. This is in agreement with the report of Uhl and Lamp (1966), which found that increasing air velocity increase the proportion of grain lost with the straw. Recent study for wheat agrees with this trend (Hollatz and Quick, 2003).

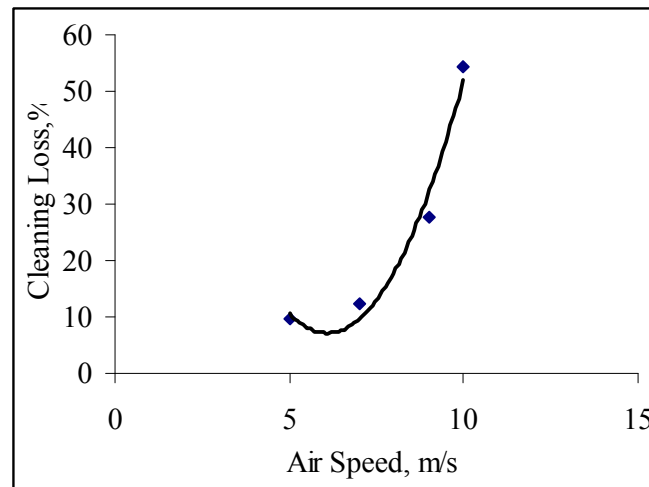

Figure 10. Effect of air speed on cleaning loss

4. CONCLUSIONS AND RECOMMENDATION

From the investigation of grain separation and cleaning efficiency distribution of a conventional stationary rasp bar sorghum thresher, the following results were obtained:

1. Grain separation along the sieve can be divided into three sections: increasing, peak and decreasing sections.
2. Cleaning efficiency decreased with increasing sieve oscillation frequency. Cleaning loss increased with increasing sieve oscillation frequency.
3. There was a decreasing in cleaning efficiency with increasing feed rate. Cleaning loss increased with increasing feed rate.
4. Cleaning efficiency decreased with increasing sieve length at different air speeds. Cleaning loss increased with increasing air speed.
5. Studies on the effect of low oscillation frequency, material inlet velocity and air stream-material contact angle should be explored.

5. REFERENCES

K. J. Simonyan and Y. D. Yiljep "Investigating Grain Separation and Cleaning Efficiency Distribution of a Conventional Stationary Rasp- bar Sorghum Thresher" *Agricultural Engineering International: the CIGR Ejournal Manuscript PM 07 028*. Vol. X. August, 2008.

- Adewumi, B. A., O. C. Ademosun and A. S. Ogunlowo. 2006. Preliminary investigation on the distribution and spread pattern of cowpea in a cross flow grain separator. *Agricultural Engineering International: the CIGR E journal*. Manuscript FP 06 020. Vol III.
- Aguirre, R. and A. E. Garray. 1999. Continuous flowing portable separator for cleaning and upgrading beans seeds and grains. *Agricultural Mechanization in Asia, Latin America and Africa* 30 (1): 59-63
- ASAE Standards. 2003. S352.2FEB03. Moisture measurement- unground grain and seeds. St Joseph, Michigan, pp 606.
- Beck, F and H. D. Kutzbach. 1996. Computer simulation of grain/chaff separation on grain pan and cleaning shoe of the combine harvester. ASAE paper 961051. St Joseph, M.I.USA
- Elfverson, C. and S. Regner. 2000. Comparative precision of grain sieve and pneumatic classification on a kernel level. *Applied Engineering in Agriculture* 16 (5): 537-541.
- Feller, R. and A. Foux. 1975. Oscillating screen motion effect on the particle passage through perforations. *Transactions of the ASAE* 18 (5): 926-931.
- Grift, T. E. 2000. Spread pattern analysis tool (SPAT) 1: Development and theoretical examples. *Transactions of ASAE* 43(6): 1341-1350.
- Harrison, H. P. and A. Blecha. 1983. Screen oscillation and aperture size- sliding only. *Transactions of the ASAE* 26 (2): 343-348.
- Henderson, S. M., R. L. Perry, and J. H. Young. 1997. *Principles of Process Engineering*. 4th Edition. ASAE. Michigan, USA. pp 280-283.
- Hollatz, B and G. R. Quick. 2003. Combine tailings returns, part 1: the effects of combine performance and settings on tailings. In *e- Proceedings of the International Conference on Crop Harvesting and Processing*. Kentucky USA. ASAE Publication Number 701P1103e. St Joseph, Mich. ASAE. 22 Pp .
- Hopfen, H. J. 1969. Farm implement for arid and tropical regions. Agricultural Development Paper No 91. FAO Rome.
- Joshi, M; N Giannico and R. L. Parish. 2006. Improved computer program for spreader pattern analysis. *Applied Engineering in Agriculture* 26(6): 799-800.
- Kutzbach, H. D. 2003. Approaches for mathematical modeling of grain separation. In *e- Proceedings of the International Conference on Crop Harvesting and Processing*. Kentucky USA. ASAE Publication Number 701P1103e. St Joseph, Mich. ASAE. 19 Pp.
- Lee, J. H. A. and R. G. Winfield. 1969. Influence of oscillating frequency on separation of wheat on a sieve in an air stream. *Transactions of the ASAE* 12(3): 886-888.
- Miu, P. I. 2003. Stochastic modeling of separation process on combine cleaning shoe. In *e-*
-
- K. J. Simonyan and Y. D. Yiljep “Investigating Grain Separation and Cleaning Efficiency Distribution of a Conventional Stationary Rasp- bar Sorghum Thresher” *Agricultural Engineering International: the CIGR Ejournal* Manuscript PM 07 028. Vol. X. August, 2008.

- Proceedings of the International Conference on Crop Harvesting and Processing.* Kentucky USA. ASAE Publication Number 701P1103e. St Joseph, Mich. ASAE. 11 Pp.
- Mkomwa, S. S. 1988. Aerodynamic separation of Alfalfa haylage into high and low protein fractions. Unpublished MSc thesis. The University of Guelph, Canada.
- Odigboh E. U. 2004. *Mechanization for enhanced agricultural productivity in Nigeria.* Edited by A P Onwualu . UNN contributions in Agricultural and Bioresources Engineering. Proceedings of a Valedictory seminar in honour of Engr (Prof) E U Odigboh . Department of Agricultural and Bioresources Engineering. University of Nigeria Press Ltd, Nsukka. 187 Pp.
- Ogunlowo ,A. S. and S. A. Adesuyi. 1999. A low cost rice cleaning and destoning machine. *Agricultural Mechanization in Asia, Africa and Latin America* 30(1): 20-24.
- Picket, L. K. and N. L. West .1988. *Agricultural machinery- functional elements- threshing, separating and cleaning.* In CRC Handbook of Engineering in Agriculture. Vol 1 Eds R. H. Brown. CRC Press. Florida USA. Pp 65-85.
- Rothaug, S; P. Wacker; W. Yin and H. D. Kutzbach .2003. Capacity increase of cleaning units by circular oscillation. *In e- Proceedings of the International Conference on Crop Harvesting and Processing.* Kentucky USA. ASAE Publication Number 701P1103e. St Joseph, Michigan. ASAE. 7 Pp.
- Uhl, J. B. and B. J. Lamp 1966. Pneumatic separation of grain and straw mixtures. *Transactions of the ASAE* 9 (2): 244-246
- Wacker, P. 2003. Influence of crop properties on the thresh ability of cereal crops. *In e- Proceedings of the International Conference on Crop Harvesting and Processing.* Kentucky USA. ASAE Publication Number 701P1103e. St Joseph, Michigan. ASAE.10 pp.
- Zhao, Y; P. Wacker and H .D. Kutzbach 1999. Investigations on winnowing steps in the combine harvester. *In proceedings of International Conference on Agricultural Engineering (99-ICAE)*, Beijing, pp 225-231.