

Design and test of a pneumatic precision metering device for wheat

Satti Hassan Yasir, Qingxi Liao, Jiajia Yu, Dali He

(College of Engineering, Huazhong Agricultural University Wuhan Hubei-Wuhan-China)

Abstract: The objective of this study was to apply the precision metering on wheat seeding to overcome seed damage, seed loss and non-uniform distribution. Accordingly, a prototype of the pneumatic precision metering device for wheat was developed. The performance of the device, including quality of feed index (QFI), multiple index (MULI), miss index (MISI) and seed rate expressed in number of kernels per meter length (KPM), was investigated under laboratory conditions in Wuhan using a test stand with camera system. The results revealed that the rotating speed (RS) and negative pressure (NP) and their interactions had a significant effect on these variables. The maximum QFI (92.98%) was obtained at rotating speed of 19.0 rpm and negative pressures of 2.5 kPa with MULI and MISI of 2.01% and 5.09%, respectively. However, the seed rate (KPM) was less than the recommended compared to previous hypothesis. The best seed rate was 53 KPM producing QFI of 89.11% with MULI and MISI of 9.00% and 1.88%, respectively at rotating speed of 34 rpm and negative pressure of 4.5 kPa. The recommended seed rates estimated at 40 KPM and 53 KPM for 12 cm and 15 cm row spacing respectively were achieved at a range of RS and NP with QFI ranging between 84.57 to 89.11%. The study demonstrated that wheat could be seeding within an acceptable precisely range by pneumatic precision metering device.

Keywords: wheat, experiments, performance indices, pneumatic precision metering device

Citation: Yasir, S. H., Q. X. Liao, J. J. Yu, and D. L. He. 2012. Design and test of a pneumatic precision metering device for wheat. *Agric Eng Int: CIGR Journal*, 14 (1): Manuscript No. 2073.

1 Introduction

A pneumatic precision metering device designed specially to meet the requirements of sowing wheat crop within the recommended seed rate to increase the productivity and decrease the production cost of wheat cultivation.

Precision planting was pioneered by Datta in 1974 as the placement of single seeds in the soil at the desired plants spacing (Datta, 1974). Usually, plant scientists use hand dibblers to achieve this degree of accuracy. Sowing devices equipped with single seed metering devices are called precision planters. The first developed precision planters were horizontal plate planters with cells on the periphery.

Presently, among different sowing techniques, precision sowing is the preferred method since it provides more uniform seed spacing than other methods.

Received date: 2011-10-16

Accepted date: 2012-03-27

¹ Corresponding author: Qingxi Liao, College of Engineering, Huazhong Agricultural University (HZAU), Hubei-Wuhan-China. Email: liaoqx@mail.hzau.edu.cn

The most commonly adopted pneumatic planters are equipped to release single seed in furrows in accordance with the desired plant spacing, by using a modular rotating seed disc under negative pressure. Seeds drilled by precision planting are sown with optimum row and within-row spacing depending on the seeding requirements for each specific crop (Bracy, Parish and McCoy, 1998). Plant spacing can affect both vegetative and reproductive growth and yield and is directly related to seed spacing uniformity.

The objective of the present study was to develop a new pneumatic precision metering device and evaluate the impact of precision seeding on wheat to overcome the inability of mass flow seed meters for saving high quality seeds, reducing the labour force used for thinning out seedling and realizing a high productivity with the minimal seed rate for economical benefit of agriculturists.

2 Literature review

The performance of a planter depends upon uniformity of seed distribution in furrows, which is difficult to measure in the field condition due to soil coverage after planting operation. Present investigation was carried out by using a test stand fitted with camera system equipped with a conveyer belt smeared with grease to evaluate the performance of a pneumatic precision metering device designed for wheat.

By comparing the vacuum and belt seeders for vegetable planting, it is observed that a vacuum seeder used 90% less seed versus the standard bulk metering planter (Parish, Bergeron and Bracy, 1991).

It is observed that uniform and spherical seeds, such as soya bean and maize are easy to meter with the vacuum metering system and concluded that the miss index decreases and the multiple index increases with increasing vacuum pressure for all seeds (Karayel et al., 2005).

The popular and widely used horizontal seed metering is having several problems, including higher seed damage, missing and multiple drops (Singh, Singh and Saraswat, 2005). Inclined and vertical plate planters were developed and used further to reduce these losses. Furthermore, the research on these above mentioned aspects led to the development of the pneumatic seed-metering device (Shafii and Holmes, 1990; Guarella, Pellerano and Pascuzzi, 1996). This mechanism has several advantages over the previous metering system including metering irregular shaped seeds, preventing seed damage, efficient and cost effective besides spherical seeds. Moreover, the most commonly adopted pneumatic planters are equipped to release single seeds in furrows as per the desired plant spacing by using a modular rotating seed disc under negative pressure.

Previously, the test stand with camera system was used to optimise the operational parameters of a pneumatic seed metering device for planting cottonseeds (Singh, Singh and Saraswat, 2005), it was reported that with the increase in pressure, the miss index value was reduced but it increased with the elevated speed. With lower vacuum pressure and at higher speeds, the metering disc does not get enough time to pick up seeds, resulting in higher miss indices. The multiple indices on the other hand are lower at higher speed but increase at higher pressure.

The fluted-roller seed meter is capable of metering seed uniformly and is commonly used as metering device for drilling of wheat but is negatively impacted by sudden release of seed batches (Maleki et al., 2006).

Another study suggested that the advantages of the pneumatic precision metering devices are no seed grading and damage. Also, the singulation is more accurate than that of plate type precision meters (Murray, Tullberg and Basnet, 2006).

The conventional fluted meters for drilling often resulted in poorly spaced stands with many gaps. To compensate for this stand variability, many operators over-seed small grains by 10-20 percent. Research shows that the conventional fluted-meter devices evaluated for variable-rate seeding are not very accurate. Fluted meters have a cup on a rotating shaft and an opening gate. The result shows that changing the shaft speed, forward speed, or gate opening greatly hinder the accuracy of population and spacing of the seed. With the increase in seed size the variability was even greater. The conventional fluted-drill meter devices do not need singulation accuracy because small grains can usually compensate for the inconsistency (Robert, et al., 2009).

The test stand with camera system was used for rapeseed to define the optimum performance parameters of the pneumatic precision metering device (Liao, Li and Qin, 2009), and established that no seed damage was observed with the pneumatic seeder and the quality of feed index, multiple index and miss index were remarkably affected by rotating speed of the metering disc and air pressure.

The performance of a modified precision vacuum seeder for no-till sowing of maize and soybean was investigated by Karayel (2009) and it was observed that increasing the forward speed of the seeder caused a decrease in multiple index and an increase in miss index.

The study on the precision metering performance of magnetic-type seeder based on machine vision using a test stand with high-speed camera system, to compare machine vision and manual detection suggested that the relative error of precision was less than 3% and coefficient of variation and standard deviation were less than 5%, which indicated the system was of high accuracy when used in real-time detection (Yang, Hu and Xie, 2010).

Materials and methods

3.1 Physical characteristics of tested wheat

50 samples of randomly selected wheat kernels of a local Chinese variety (*hua mai 13*), were measured for length, width, thickness, mass (n=1000 seeds), projected area, volume, geometric mean diameter and sphericity (defined as ratio of diameter of the largest inscribed circle over diameter of the largest circumscribed diameter of the seed) as given in Table 1.

Table 1 Physical characteristics of wheat kernels

Physical properties	min	max	mean	SE of mean	95% confidence limit
Length l, mm	5.86	7.38	6.57	0.14	6.57 ± 0.26
Width w, mm	3.10	3.88	3.63	0.10	3.63 ± 0.20
Thickness t, mm	2.84	3.74	3.23	0.11	3.23 ± 0.20
Sphericity*%	0.62	0.63	0.63	0.035	0.63 ± 0.06
1000 seed mass, g	41.40	48.1	44.17	0.34	44.17 ± 0.66
Projected area mm ²	11.46	16.03	13.88	0.30	13.88 ± 0.58
Geometric mean diameter mm	3.81	4.51	4.19	0.08	4.19 ± 0.16
Volume cm ³	30.18	50.13	40.33	0.17	40.33 ± 0.34

* sphericity, defined as ratio of diameter of the largest inscribed circle over diameter of the largest circumscribed diameter of the seed. SE is standard error

3.2 Determination of angle of repose for wheat

As is shown in Figure 1(a), the angle of repose was very essential for designing the seed box of our machine to insure the continuous flow of wheat kernels to the seed lot. Our experiment observed that angle of repose for wheat was 28° which was in accordance with the findings of Clover (1998) (Table 2). For determination of this angle an apparatus was used as is shown in Figure 1(b), in which the kernels were left to flow freely and gently through a cylindrical tube to the base. The leg opposite and average of four values for leg adjacent were measured in Figure 1(c). The test was repeated five times and the average was measured.

$$\theta = \arctan \frac{\text{leg opposite}}{\text{leg adjacent}} \quad (1)$$

Where: θ is the angle of repose.

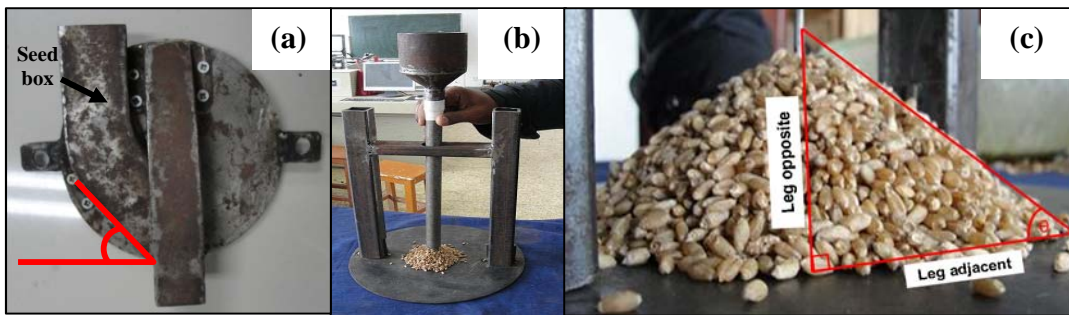

Figure 1 Determination of angle of repose
(a) the angle of seed box (b) apparatus used in the test (c) measurement of opposite and adjacent legs

Table 2 determination of angle of repose

No. of tests	Leg opposite (cm)	Leg adjacent cm				av. Leg adjacent (cm)	Angle (degrees)
		1	2	3	4		
1	4.50	9.50	9.30	9.30	8.80	9.23	26.00
2	4.60	9.10	8.50	8.40	8.10	8.53	28.35
3	4.70	8.20	7.20	8.60	8.20	8.05	30.28
4	4.70	8.10	8.10	7.70	7.90	7.95	30.59
5	3.30	5.70	5.70	6.60	6.00	6.00	28.81
average				28.38°			

3.3 key parts of the pneumatic precision metering device for wheat

The metering device (Figure 2) consisted of a seed box and seed tube with falling height of 140 mm and all of these were fixed in one removable shield. The seed inlet was positioned at the bottom of this shield. The best diameter of seed inlet from experiments was found to be 27 mm to control the seed flow and seed choke. The shield was fixed to another removable steel ring in Figure 3(b), and both were fixed to the main shield. The main shield consisted of driving shaft, negative pressure inlet and seed plate. The negative pressure chamber was made around the seed plate after the ring was fixed to the main shield.

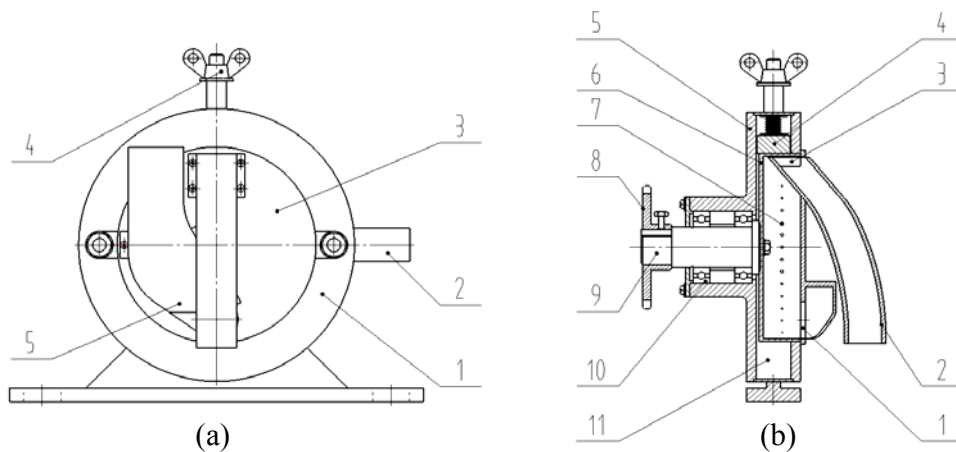

Figure 2 Schematic diagram of the pneumatic precision metering device for wheat

- (a) 1-removable steel ring 2-negative pressure inlet 3-removable shield
 4-adjustable round wing nut 5-seed box (b) 1-seed inlet 2-seed tube 3-seed outlet 4-spring loaded PVC air cut-off device 5-main shield 6-seed plate 7-seed hole 8-gear 9-driving shaft 10-bearings 11-chamber of negative pressure

The main shield of the device in Figure 3(a) was manufactured of steel, with 200 mm outside diameter, 26 mm depth and total width of 73 mm and equipped with a driving shaft and could be easily joined to the testing bench or planter frame.

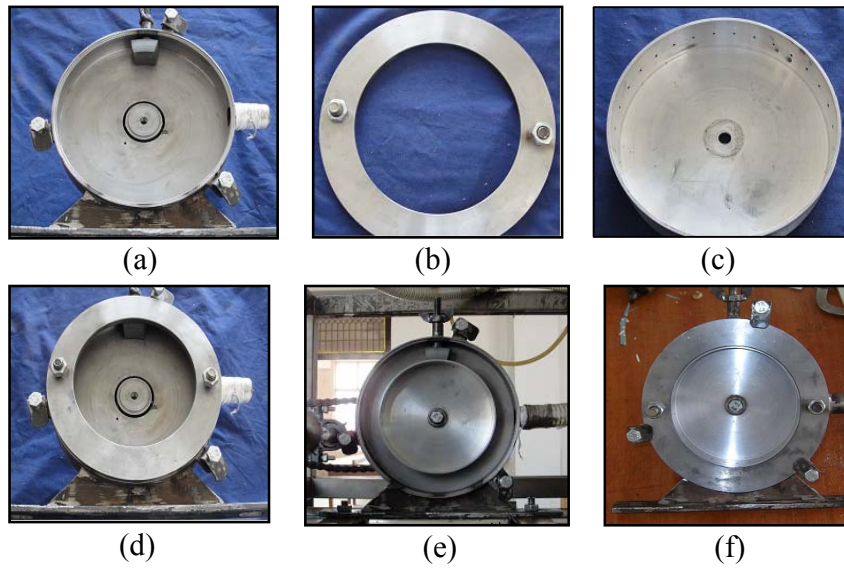

Figure 3: Main parts of the pneumatic precision metering device for wheat
 (a) the main shield with air cut-off device (b) the removable ring (c) the seed plate
 (d) the ring fixed to the main shield (e) the seed plate inside the main shield (f) the
 main shield seed plate and removable ring fixed together as one unit

The seed plate in Figure 3(c) was made of aluminium and was designed to have two functions. Besides metering kernels, the plate also worked as seed lot having 140 mm diameter with 30 equidistant cylindrical holes and 2 mm thickness. The total width was 30 mm; the plate was made to have a depth of 27 mm in order to accommodate kernels. The diameter of the seed hole was 1.8 mm based on $\leq 50\%$ size of the geometric mean diameter for wheat. Depending upon the small diameter of seed hole along with the influence of rotating speed of the seed plate and gravity, the singulation could be achieved. A circular cavity of 35 mm diameter and 1 mm depth was made at the back side of the plate to secure stability during fixing and rotating of the driving shaft. In this design, making the kernels to move within the seed plate enhances the pick up process.

3.4 Operating principles

As is shown in Figure 4, kernels enter through seed inlet at the bottom of the seed plate which also worked as a seed lot. The kernels stir according to the movement of the seed plate, and then they are picked up by seed holes at the bottom of the seed plate, and are held and transported under effect of negative pressure. Influenced by a spring loaded PVC air cut-off device positioned at the top of the seed plate, the negative pressure drops and the kernels then fall down vertically by gravity via the outlet to the seed tube.



Figure4 Operating principle

(a) kernels picked-up and released (b) kernels fall down through seed outlet

3.5 Experiments and equipment

3.5.1 Objective of the design

The experiments on this design were conducted under laboratory conditions in order to:

- 1- Optimize the seed uniformity distribution and operational parameters based on the quality of feed index (QFI), multiple index (MULI) and miss index (MISI)
- 2- Determine the seed rate expressed as number of kernels per meter length (KPM)
- 3- Evaluate the possibility of the non-spherical seeds through this metering device

3.5.2 Instruments and equipment used in the experiments

3.5.2.1 Test stand with camera system

A test stand with high-speed camera system (Figure 5) was used for laboratory testing. The system was provided with a variable speed motor to control the rotating speed. A greased belt was provided to receive seeds, and an oil pump kept the belt smeared in order to secure the seeds to the belt surface, preventing rolling or bouncing. A compressor was used to generate the pressure through the system, while a U-shape manometer was equipped to control the negative pressure.

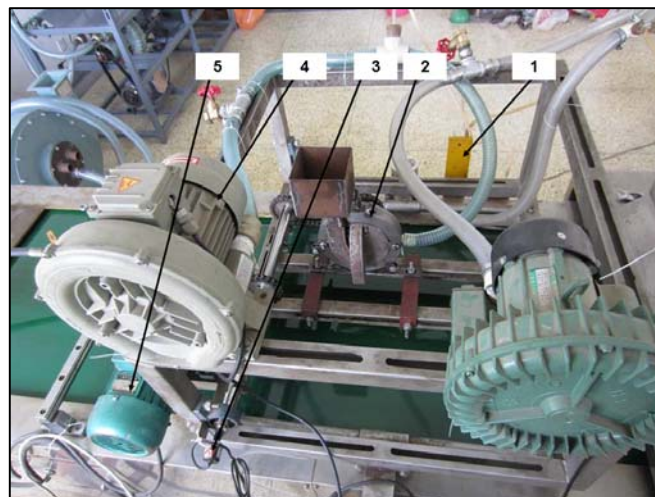

Figure 5 Metering device on the test stand

- 1- U-shape manometer
- 2-the metering device
- 3-sensor
- 4-compressor
- 5-advanced variable speed motor

3.5.3 Experimental design

The new device was designed to have one plate with 30 holes of 1.8 mm diameter each. A 5x5 RCB statistical design was applied with five levels of the rotational speed (19, 24, 29, 34 and 39 rpm) and five levels of the negative pressure (2.5, 3.0, 3.5, 4.0 and 4.5 kPa). Belt speed was constant at 2 km.h⁻¹.

The theoretical spacing is given by the following simple formula:

$$\text{theoretical spacing (mm)} = \frac{\text{belt speed (km.h}^{-1}) \times 1000000}{60 \times \text{rotational speed (rpm)} \times \text{number of holes}} \quad (2)$$

The seed spacing on the greased belt was measured manually from 30 meter length, every 10 meter represents one replication, and then the quality of feed index (QFI), multiple index (MULI), miss index (MISI) and number of kernels per meter (KPM) were calculated. The data obtained were statistically analyzed using SAS software version 9.1 to determine the effect of rotating speed (RS) and negative pressure (NP) on the above mentioned variables.

As stated by Singh, Singh and Saraswat (2005), the performance parameters for the pneumatic planter are as follows:

1) Miss index (MISI)

The miss index I_{miss} is the percentage of spacing greater than 1.5 times the set planting distance S in mm.

$$I_{miss} = \frac{n_1}{N} \quad (3)$$

Where: n_1 is number of spacing $> 1.5 S$; and N is total number of measured spacing.

2) Multiple index (MULI)

The multiple index I_{mult} is the percentage of spacing that are less than or equal to half of the set plant distance S in mm.

$$I_{mult} = \frac{n_2}{N} \quad (4)$$

Where: n_2 is number of spacing $\leq 0.5 S$.

3) Quality of feed index (QFI)

The quality of feed index I_q is the percentage of spacing that are more than half but not more than 1.5 times the set planting distance S in mm. The quality of feed index is an alternate way of presenting the performance of misses and multiples.

$$I_{qfi} = 100 - (I_{miss} + I_{mult}) \quad (5)$$

4) Number of kernels per meter length (KPM)

Referring to the recommended seed rate for wheat, the number of kernels per meter length (KPM) was calculated from randomly selected sequence of kernels distributed on the grease belt after operating the pneumatic precision metering device for wheat within a range of 100 cm length three times for every experiment to evaluate the seed rate according to the selected RS and NP.

4 Results and discussion

The data were analysed with one-way and two-way ANOVA to determine the best RS and NP to give the best seed rate within a reasonable QFI (one-way ANOVA), as well as determining the influence of the two factors on the dependent variables (two-way ANOVA).

4.1 Realizing the recommended seed rate within a reasonable quality of feed index (QFI)

The results of the effect of NP and RS on QFI, MULI and MISI were listed in Table 3. The values superscripted by capital letters indicated the Duncan's multiple range test (DMRT). Seed damage was also investigated on the greased belt and inside the metering device. The distribution of wheat kernels for some treatments on the greased belt is shown in Figure 6.

Table 3 Effect of rotating speed and negative pressure on QFI, MULI, MISI and KPM

RS*NP	QFI		MULI		MISI		KPM	
	Rank	Mean	Rank	Mean	Rank	Mean	Rank	Mean
19*2.5	1	92.89 ^A	25	2.01 ^I	15	5.09 ^{DEFGH}	25	24 ^J
19*3.0	8	87.90 ^{AB}	15	6.79 ^{CDEFGH}	14	5.30 ^{DEFG}	24	25 ^J
19*3.5	3	88.91 ^{AB}	3	11.09 ^{ABC}	25	0.00 ^J	20	27 ^{HIJ}
19*4.0	12	86.96 ^{BC}	1	12.66 ^A	23	0.44 ^J	22	27 ^{HIJ}
24*4.5	4	88.85 ^{AB}	4	11.03 ^{ABC}	24	0.11 ^J	23	26 ^{IJ}
24*2.5	9	87.26 ^B	22	11.03 ^{FGHI}	7	8.13 ^{CD}	19	30 ^{GHI}
24*3.0	23	79.11 ^{FG}	20	5.59 ^{CDEFGH}	3	16.29 ^B	21	27 ^{HIJ}
24*3.5	13	86.52 ^{BC}	9	9.47 ^{ABCDE}	16	4.00 ^{EFGHI}	18	32 ^{FGH}
24*4.0	5	88.42 ^{AB}	5	10.22 ^{ABCD}	22	1.34 ^{JHI}	16	34 ^{DEFG}
24*4.5	15	86.44 ^{BC}	2	11.97 ^{AB}	21	1.57 ^{GHIJ}	11	39 ^{CD}
29*2.5	22	80.39 ^{EFG}	21	5.42 ^{EFGHI}	5	14.18 ^B	17	33 ^{EFG}
29*3.0	16	86.05 ^{BCD}	17	6.26 ^{DEFGHI}	9	7.68 ^{CDE}	15	35 ^{DEF}
29*3.5	20	81.93 ^{CDEF}	7	9.96 ^{ABCDE}	8	8.10 ^{CD}	13	38 ^D
29*4.0	7	88.04 ^{AB}	6	10.20 ^{ABCD}	19	1.76 ^{GHIJ}	6	45 ^B
29*4.5	6	88.27 ^{AB}	8	9.65 ^{ABCDE}	20	1.74 ^{GHIJ}	9	43 ^{BC}
34*2.5	25	76.03 ^G	23	3.66 ^{HGI}	1	20.30 ^A	14	37 ^{DE}
34*3.0	11	87.18 ^B	19	6.01 ^{DEFGHI}	10	6.80 ^{CDEF}	8	43 ^{BC}
34*3.5	17	85.12 ^{BCDE}	12	8.89 ^{ABCDEF}	12	5.98 ^{CDEF}	10	43 ^{BC}
34*4.0	10	87.20 ^B	10	9.13 ^{ABCDEF}	17	3.66 ^{FGHIJ}	4	50 ^A
34*4.5	2	89.11 ^{AB}	11	9.00 ^{ABCDEF}	18	1.88 ^{GHIJ}	2	53 ^A
39*2.5	21	81.37 ^{DEF}	24	2.46 ^{HI}	4	16.16 ^B	12	38 ^D
39*3.0	24	78.96 ^{GF}	16	6.66 ^{CDEFGH}	2	16.71 ^B	7	44 ^B
39*3.5	19	84.57 ^{BCDE}	18	6.20 ^{DEFGHI}	6	9.22 ^C	5	45 ^B
39*4.0	14	86.46 ^{BC}	14	7.74 ^{BCDEFG}	13	5.79 ^{CDEF}	3	52 ^A
39*4.5	18	84.90 ^{BCDE}	13	8.52 ^{ABCDEF}	11	6.57 ^{CDEF}	1	53 ^A

Note: Means with the same letter are not significantly different

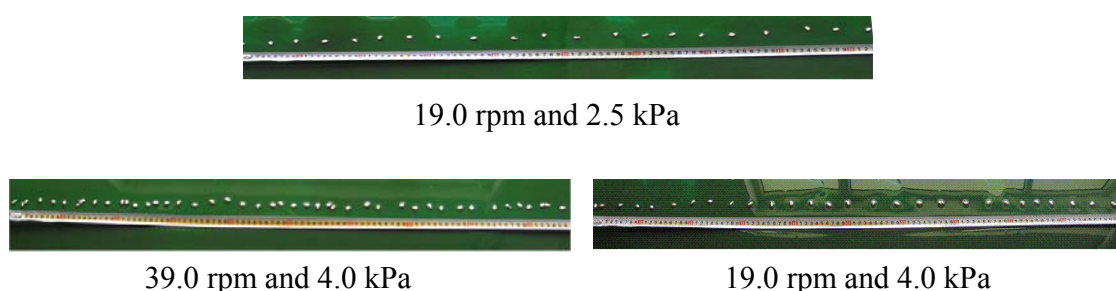

Figure 6 kernels distribution under different levels of rotating speed and negative pressure

The statistical analysis revealed that the highest QFI (92.89 %) was observed at rotating speed of 19.0 rpm and negative pressure of 2.5 kPa, whereas the corresponding values of MULI and MISI at these levels were 2.01 % and 5.09 %, respectively. This finding was also supported through the uniform distribution demonstrated in Figure 5 under the different treatments.

The highest MULI (12.66%) was obtained at rotating speed of 19.0 rpm and negative pressure of 4.0 kPa, while the lowest MULI (2.01%) resulted from rotating speed of 19.0 rpm and negative pressure of 2.5 kPa. At high pressure and low speed multiple kernels were picked up by seed hole and released at the same time and accordingly, the seed spacing decreased. Our results supported the previous observations of Singh, Singh and Saraswat, 2005.

For MISI, the highest value 20.30% was observed at rotating speed of 34.0 rpm and negative pressure of 2.5 kPa, while the lowest value 0.00% was observed at rotating speed of 19.0 rpm and negative pressure of 3.5 kPa. At the same level of rotating speed and negative pressure of 4.0 kPa and 4.5 kPa respectively, the MISI was observed to be very low (less than 1.0 %), which indicated that the value of MISI was inversely proportional with the negative pressure and directly proportional with rotating speed. This result was also in agreement with Singh, Singh and Saraswat (2005).

Figure 6 also highlights that increasing the RS decreases the seed spacing, however, with increased negative pressure, multiple kernels were metered and resulted in an increase of MULI. The seed damage was observed to be zero over all treatments on the greased belt and inside the seed lot.

As stated by HGCA (2000), 15 varieties of wheat were investigated using two seed rates (320 seeds.m⁻² and 80 seeds.m⁻²). The results showed that varieties had similar mean yields (t.ha⁻¹) and had no effect on optimum plant production. Considering that the QFI for precision seeding should be at least greater than or equal to 82.3%, it can be observed that the pneumatic precision metering device for wheat could achieve a uniform distribution and seed rates estimated at 40 KPM and 53 KPM in case of 12 cm and 15 cm row spacing respectively and within a reasonable percentages of QFI. From Table 3, the recommended seed rate expressed as kernels per meter length (KPM) could be realized by this metering device in a range of rotating speed (RS) and negative pressure (NP) including 24 rpm with 4.5 kPa, 29 rpm with 4.0 and 4.5 kPa, 34 rpm with 3.0 and 3.5 kPa and 29 rpm with 3.5 for 12 cm row spacing, whereas, for 15 cm row spacing the seed rate could be achieved using 34 rpm and 39 rpm with 4.0 and 4.5 kPa.

4.2 The effect of RS and NP on QFI, MULI, MISI and KPM

Two-way ANOVA was also used for data analysis to study the relationship between QFI, MULI and MISI and different levels of RS and NP as shown in Table 4 and 5 and Figure 7 and 8. The results revealed that with increase in negative pressure, the QFI and MULI increases while the MISI decreases, whereas with increasing the rotating speed, the QFI and MULI decreases and the MISI increases. This may be attributed to the failure of seed plate to have enough kernels with increasing rotating speed.

Table 4 Duncan’s multiple range test for variables under influence of negative pressure

<i>NP</i>	<i>QFI</i>	<i>MULI</i>	<i>MISI</i>	KPM
2.5	83.59 ^a	3.64 ^a	12.77 ^a	32 ^a
3.0	83.84 ^a	6.26 ^a	10.56 ^b	35 ^a
3.5	85.41 ^b	9.12 ^a	5.46 ^c	37 ^b
4.0	87.42 ^b	9.99 ^b	2.60 ^d	42 ^c
4.5	87.51 ^b	10.04 ^c	2.38 ^d	43 ^d

Note: Means with the same letter are not significantly different

Table 5 Duncan’s multiple range test for variables under influence of rotating speed

<i>RS</i>	<i>QFI</i>	<i>MULI</i>	<i>MISI</i>	KPM
19	89.10 ^a	8.72 ^a	2.19 ^a	26 ^a
24	85.55 ^b	8.38 ^a	6.27 ^b	33 ^a
29	84.94 ^{bc}	8.30 ^a	6.69 ^b	39 ^b
34	84.93 ^{bc}	7.34 ^{ab}	7.72 ^b	45 ^c
39	83.26 ^c	6.32 ^b	10.89 ^c	46 ^d

Note: Means with the same letter are not significantly different

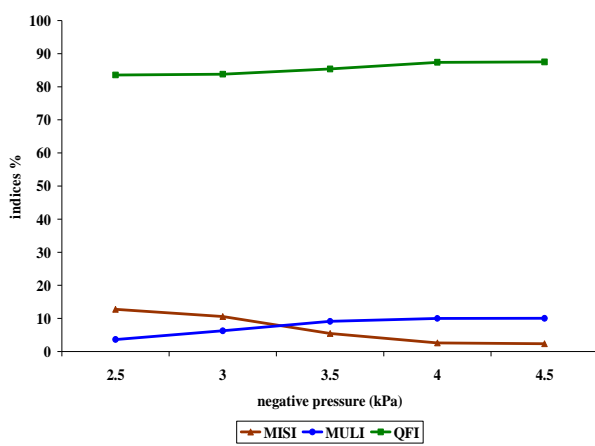

Figure 7 Effect of negative pressure on performance indices

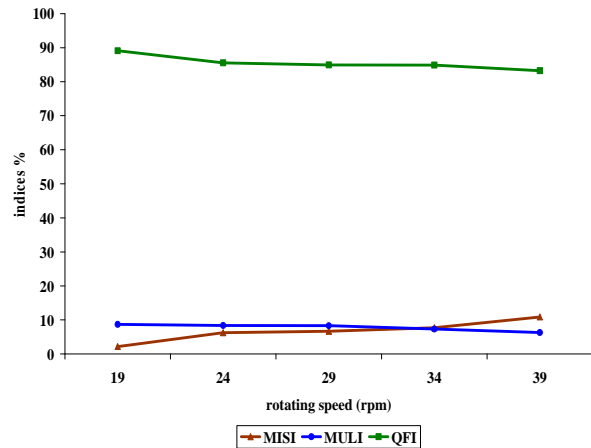

Figure 8 Effect of rotating speed on performance indices

The influence of RS and NP on KPM was listed in Figure 9 and Figure 10. With the increasing of NP, the ability of seed holes to pick up kernels increases. The increase of RS, increases the seed rate (number of kernels/time) as well, which in turn increases the KPM, as is shown in Figure 9 and Figure 10.

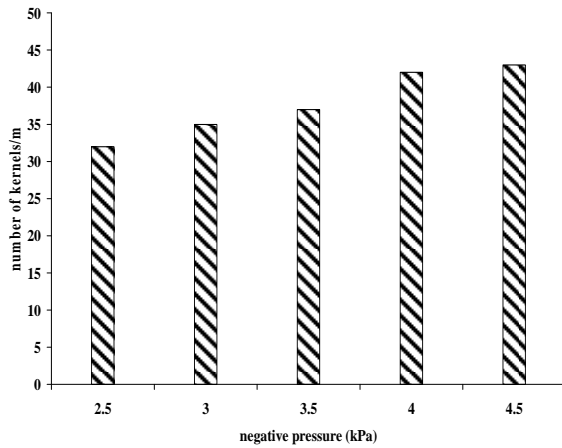

Figure 9 Effect of negative pressure on number of kernels per meter

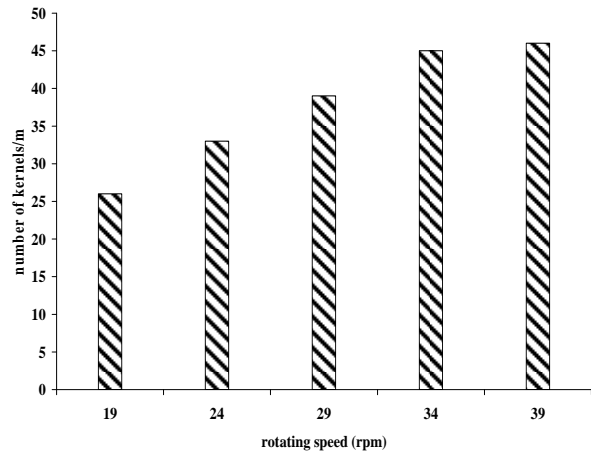

Figure 10 Effect of rotating speed on number of kernels per meter

4.3 Significance and correlations between QFI, MULI, MISI, KPM RS and NP

The performance of the pneumatic precision metering device under laboratory conditions in respect to the influence of RS and NP on uniformity of kernel distribution was statistically analysed. Quality of feed index, multiple index, miss index, and number of kernels per meter length were combined for analysis of variance to determine the significant differences in the variability among the parameters.

As is shown in Table 6, the statistical analysis revealed that the QFI, MISI and KPM were significantly affected by RS and NP and their interaction at 1% level of significance. For MULI the effect of RS was significant at 5% level of significance whereas the effect of NP was significant at 1% level of significance, while the interaction of the two factors showed no significant difference in the value of MULI. The values of standard error of the mean as exposed in Table 6 were observed to be very small which indicated the accuracy of the sample mean.

Table 6 Influence of rotating speed (RS), negative pressure (NP) and their interaction on variables under laboratory conditions

variables	min	max	mean	s.d.	s.e.	Pr > F		
						RS	NP	RS*NP
QFI	74.75	94.04	85.56	4.43	2.04	9.71**	7.63**	5.19**
MULI	1.53	16.00	7.81	3.42	0.71	2.95*	24.03**	7.44
MISI	0.00	22.10	6.75	6.00	1.89	33.17**	75.32**	7.26**
KPM	23	53	37.35	9.24	1.51	155.04**	41.97**	2.86**

** , significant at 1% level of significance, * significant at 5% level of significance s.d., standard deviation, s.e., standard error

The correlation (Table 7) between variables from statistical analysis highlighted that, as the QFI increases the MULI increases and both of MISI and KPM decreases, whereas, with the

increase in MULI, the MISI decreases and the KPM increases and the MISI is negatively correlated with KPM.

Table 7 Correlation between variables

indices	QFI	MULI	MISI	KPM
QFI	1.00000	0.06379	-0.80750	-0.08199
MULI		1.00000	-0.62380	0.11808
MISI			1.00000	-0.00760
KPM				1.00000

5 Conclusions:

- The pneumatic precision metering device for wheat could be successfully used for precision metering for wheat at different levels of speeds and negative pressure;
- The statistical analysis revealed that the QFI, MULI, MISI and KPM were significantly affected by RS and NP. The best QFI (92.98 %) was obtained at rotating speed of 19.0 rpm and 2.5 kPa and negative pressures of 2.5 kPa with KPM of 24 kernels.m⁻¹;
- The recommended seed rate was realized at a range of rotating speed and negative pressure, however, the best result was obtained at rotating speed of 34 rpm and negative pressure of 4.5 kPa, and the QFI at these levels was 89.11 % with MULI of 9.00 % and MISI of 1.88 % and 53 KPM;
- The experiment proved that the non-spherical seeds were convenient to be metered with this device;
- Seed damage was observed to be zero over all treatments which is an advantage over conventional metering devices which are commonly used for metering wheat;
- The QFI and MULI were observed to be increased and the MISI decreased with the increase in negative pressure, whereas, the QFI and MULI were decreased and MISI increased with increase in the rotating speed;

Acknowledgements

We greatly acknowledge the efforts of Mayank Gautam (Huazhong Agricultural University) for critically reading and editing the English version of the manuscript. We are indebted to the fund for Modern Agro-industry Technology Research System (CARS-13), the Fundamental Research Funds for the Central Universities (2011PY021) and Ministry of Higher Education and Scientific research (Sudan) for their financial support, many thanks also go to Professor Liao Qingxi of Huazhong Agricultura University (HZAU), for his constant encouragement, inquiries, constructive criticism, and invaluable supervision. A final word of appreciation goes to the staff members and colleagues of the department of Agricultural Mechanization research at HZAU, Wuhan. China.

References

- Bracy, R. P., R. L. Parish, and J. E. McCoy. 1998. Precision seeder uniformity varies with theoretical spacing. ASAE Paper No. 981095. ASAE, St. Joseph, MI.
- Clover, Thomas J. Pocket Ref. Littleton, (1998) Colorado: Sequoia Publishing, Inc. http://en.wikipedia.org/wiki/Angle_of_repose, April 2010

- Datta, R. K. 1974. Development of some seeders with particular reference to pneumatic seed drills. *The Harvester*, Indian Institute of Technology, Kharagpur, India, 16, 26-29.
- Grisso, R. B., D. Holshouser, and R. Pitman. 2009. Planter/Drill Considerations for Conservation Tillage Systems. College of Agriculture and Life Sciences, Virginia Polytechnic Institute and State University, publication 442-457.
- Guarella, P., A. Pellerano, and S. Pascuzzi. 1996. Experimental and theoretical performance of a vacuum seed nozzle for vegetable seeds. *Journal of Agricultural Engineering Research*, 64 (1): 29-36.
- Home-Grown Cereals Authority (HGCA). 2000. Research & Development Caledonia House 223 Pentonville Road London N1 9HY.
- Karayel, D. 2009. Performance of a modified precision vacuum seeder for no-till sowing of maize and soybean. *Soil & Tillage Research*, 104 (1): 121-125.
- Karayel, D., M. Wiesehoff, A. Özmerzi, and J. Müller. 2006. Laboratory measurement of seed drill seed spacing and velocity of fall of seeds using high-speed camera system. *Computers and Electronics in Agriculture*, 50 (2): 89-96.
- Lan, Y., M. F. Kocher, and J. A. Smith. 1999. Opto-electronic sensor system for laboratory measurement of planter seed spacing with small seeds. *J. Agric. Eng. Res.*, 72 (2): 119-127.
- Liao, Q. X., J. B. Li, and G. L. Qin. 2009. Experiment of pneumatic precision metering device for rapeseed. *Transactions of the Chinese Society of Agricultural Machinery*, 40 (8): 44-48.
- Maleki, M. R., J. F. Jafari, M. H. Raufat, A. M. Mouazen, and J. De Baerdemaeker. 2006. Evaluation of seed distribution uniformity of a multi-flight auger as a grain drill metering device. *Biosystems Engineering*, 94 (4): 535-543.
- Murray, J. R., J. N. Tullberg, and B. B. Basnet. 2006. Planters and their components, types, attributes, functional requirements, classification and description. School of Agronomy and Horticulture, University of Queensland, Australia, 135-137.
- Parish, R. L., P. E. Bergeron, and R. P. Bracy. 1991. Comparison of vacuum and belt seeders for vegetable planting. *Applied Engineering in Agriculture*, 7 (5): 537-540.
- Shafii, S., and R. G. Holmes. 1990. Air jet seed metering a theoretical and experimental study. *Transactions of the ASAE*, 33 (5): 1432-1438.
- Singh, R. C., G. Singh, and D. C. Saraswat. 2005. Optimization of design an operational parameters of a pneumatic seed metering device for planting cottonseeds. *Biosystems Engineering*, 92 (4): 429-438.
- Yang, D. Y., J. P. Hu, and Z. Q. Xie. 2010. Detection technology for precision metering performance of magnetic-type seeder based on machine vision. Computer and Computing Technologies in Agriculture IV. 4th IFIP TC 12 conference, CCTA 2010, selected papers, part 1, 555-562.